

All India Mock Test of SBI Clerk Mains – Solutions

Solutions (1-5): The difference between the present age of A and C is 9 less than the difference between the present ages of the one who like black and white. The number of persons born before D is same as the number of persons born after B. More than one person born between A and C. Not more than three persons born between the ones who like Black and White. Only one person is born between the one who like pink color and black color. B likes Red color. From this we get two possible cases:

	Case 1	Case 2
Year	Person(color)	Person(color)
1942(76)	A/C	A/C
1955(63)	Black/White	Black/White
1961(57)	B(Red)	D
1983(35)	A/C (Pink)	A/C (Pink)
1994(24)	D	B(Red)
2005(13)	Black/White	Black/White
2008(10)		

The difference between the age of E and G is a prime number and G likes yellow color. The sum of the ages of A, B and E is not an odd number. F doesn't like black color.

	Case 1a	Case 1b	Case 2a	Case2b
Year	Person(color)	Person(color)	Person(color)	Person(color)
1942(76)	A	A	C	C
1955(63)	E(Black)	F(White)	E(Black)	F(White)
1961(57)	B(Red)	B(Red)	D	D
1983(35)	C (Pink)	C (Pink)	A (Pink)	A(Pink)
1994(24)	D	D	B(Red)	B(Red)
2005(13)	F(White)	E(Black)	F(White)	E(Black)
2008(10)	G(Yellow)	G(Yellow)	G(Yellow)	G(Yellow)

The one who like blue color is not younger than the one who likes purple. And C doesn't like blue color. From this case 2a and 2b gets eliminated. The one who likes purple color is younger than the one who likes black color. From this case 1b also gets eliminated and we get the final solution.

Year	Person(color)
1942(76)	A(Blue)
1955(63)	E(Black)
1961(57)	B(Red)
1983(35)	C(Pink)
1994(24)	D(Purple)
2005(13)	F(White)
2008(10)	G(Yellow)

S1. Ans.(e)

S2. Ans.(e)

S3. Ans.(b)

S4. Ans.(b)

S5. Ans.(e)

Solutions (6-10):

Logic: As a first step let's first understand the logic behind the Output. Words are arranged from left end and numbers are arranged from right end. In each step one word and one number are arranged.

Word – Words are arranged in ascending order according to the sum of the place value of all letters of word. If the sum of two or more words are same than arranged according alphabetic series.

Number- Numbers are arranged in descending order according to the sum of the digits of the number.

Input: 637 neat lift 382 high 813 quit 492 goal 797 kick 441

Step I: high 637 neat lift 382 813 quit 492 goal kick 441 797

Step II: high kick neat lift 382 813 quit 492 goal 441 797 637

Step III: high kick goal neat lift 382 813 quit 441 797 637 492

Step IV: high kick goal neat lift quit 813 441 797 637 492 382

Step V: high kick goal neat lift quit 441 797 637 492 382 813

Step VI: high kick goal neat lift quit 797 637 492 382 813 441

Step VI is the last step of the rearrangement.

S6. Ans.(e)

S7. Ans.(d)

S8. Ans.(b)

S9. Ans.(a)

S10. Ans.(c)

S11. Ans.(d)

Sol.

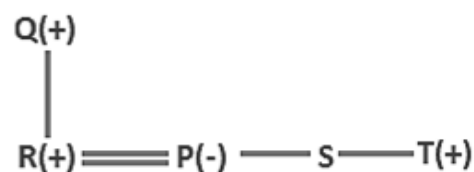

S12. Ans.(d)

Sol.

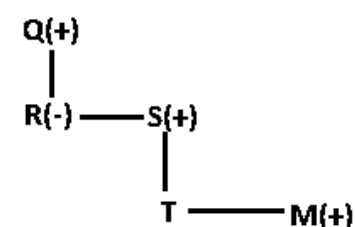

NRA-CET Ready

BANK

Useful for Bank & Insurance Exams

TEST PACK

12 Months Subscription

S13. Ans.(b)

J(+) = K(-) — L — N(+) — M(+)

S14. Ans.(e)

J(+) = K(-) — L — N(+) — M(+)

Solutions (15-19): L sits third to the right of the one who likes Firozi color. Only two persons sit between L and Q. The one who likes Red color sits on the immediate left of Q. From these conditions we have four possible cases-

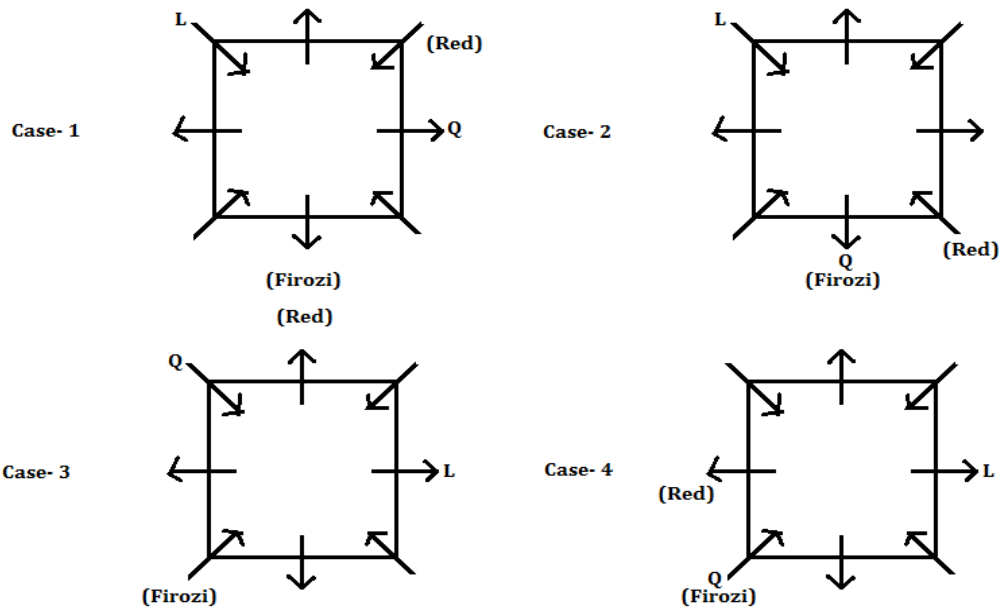

P is an immediate neighbour of neither Q nor L. P does not like Firozi color. The one who likes Violet color sits second to the left of P. Only one person sits between J and the one who likes Violet color. M sits on the immediate right of the one who likes Blue color. P does not like Blue color. N likes Navy color and is not an immediate neighbour of J. By this condition case- 2 and case- 4 are cancelled. So new arrangement will be-

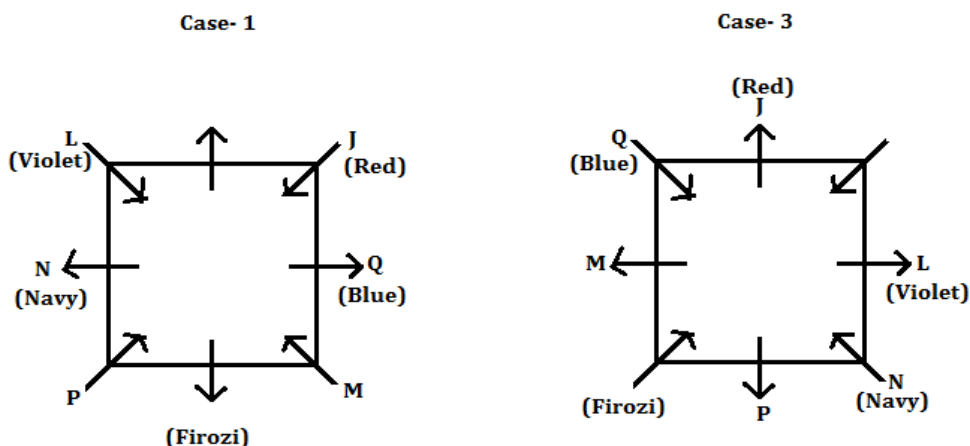

The one who likes Pink color is an immediate neighbour of N. The one who likes Orange color is an immediate neighbour of O. K does not sit in the middle of any of the sides of table. By this conditions case-1 is cancelled. So final arrangement will be-

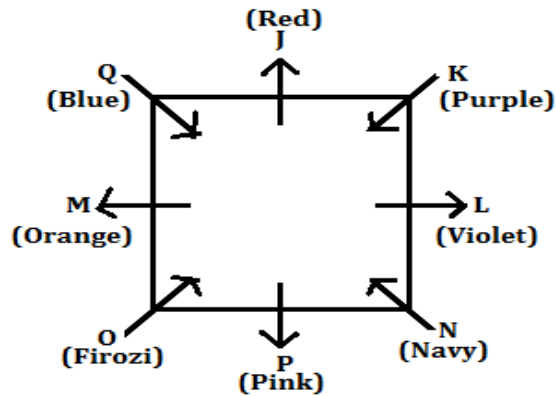

S15. Ans.(b)

S16. Ans.(c)

S17. Ans.(c)

S18. Ans.(b)

S19. Ans.(d)

S20. Ans.(a)

Sol. I is necessary to solve the problem. II and III are not advisable because the matter is very sensitive. The problem is not of one or two sugar mills. All sugar mill owners are opposing the decision of the government.

S21. Ans.(b)

Sol. For I : Yes, it is an immediate course of action because HRD minister should conduct the thorough inquiry to protect its credibility and stop any further leak of papers.

For II. No, it is not the immediate course of action as it is a harsh course of action against all the CBSE officers inspite of punishing those who found guilty after the inquiry.

For III. Yes, it is an immediate course of action as the leak papers of class 12th and class 10th should be conducted fairly with the view to uphold the sanctity of Board examinations and in the favour of all the hard-working students.

S22. Ans.(e)

Sol. The data given in both I and II together are sufficient to answer the question.

B is the granddaughter of D.

S23. Ans.(e)

Sol. The data given in both I and II together are sufficient to answer the question.

From both I and II:

Floor	Person
5	A/B
4	C
3	D
2	-
1	B/A

S24. Ans.(d)

Sol. The data given in both I and II together are not sufficient to answer the question.

S25. Ans.(c)

Sol. The data given in either I or II is sufficient to answer the question.

Code for 'not' is 'im'.

Solutions (26-28):

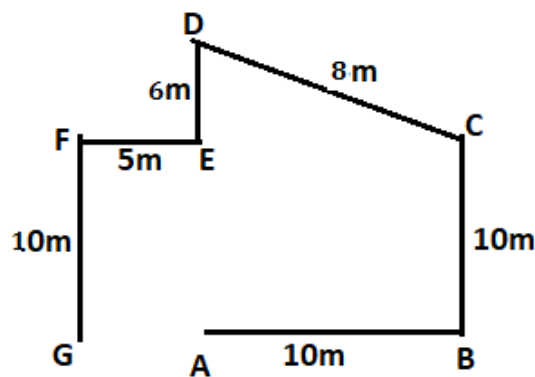

S26. Ans.(c)

S27. Ans.(b)

S28. Ans.(a)

Solutions (29-33): Box N's weight is 32kg, contains Peda and placed at odd numbered but lesser than 5th position. Only one box is placed between the boxes which contain Laddu and Peda. From these conditions we have three possible cases. Box S contains Gujia and placed at 4th position and the weight of the box is either multiple of 17 or a prime number.

TEST SERIES

Bilingual

Video Solutions



**RBI ASSISTANT
MAINS**

25 Total Tests | eBooks

	Case- 1		Case- 2		Case- 3	
Position	Box	Sweet	Box	Sweet	Box	Sweet
8 th						
7 th						
6 th						
5 th				Laddu		
4 th	S	Gujia	S	Gujia	S	Gujia
3 rd	N	Peda	N	Peda		Laddu
2 nd						
1 st		Laddu			N	Peda

S/ > > > S/ > > S/ > N >
 53 kg 50 kg 46 kg 41 kg 35 kg 34 kg 32 kg 30 kg

Only one box is placed between the boxes which contain Imarti and Burfi, both are placed at even number position. The box which contains Ghevar is placed just above the box which contains Imarti. Box T contains Burfi and is lighter than box Q, which contains Imarti. Box U contains Kateli. Box which contains Kateli is of 30kg and is placed just below the box which contains Imarti. By this condition case- 2 is cancelled. So new arrangement will be-

	Case- 1		Case- 3	
Position	Box	Sweet	Box	Sweet
8 th	T	Burfi	T	Burfi
7 th		Ghevar		Ghevar
6 th	Q	Imarti	Q	Imarti
5 th	U	Kateli	U	Kateli
4 th	S	Gujia	S	Gujia
3 rd	N	Peda		Laddu
2 nd				
1 st		Laddu	N	Peda

S/ > > > S/ > > S/ > N > U Q > T
 53 kg 50 kg 46 kg 41 kg 35 kg 34 kg 32 kg 30 kg

Box P contains Jalebi. Box Q is 5kg lighter than Box M, which contains Laddu. So box Q is of 41kg and box M is of 46kg. The box which placed just below box U is not the heaviest box. So box S is of 34kg. The box which contains Ghevar is of 50kg. So box R is of 50kg. Box M is not placed just below the box which is of 53kg. By this condition case- 1 is cancelled. So final arrangement will be-

Position	Box	Sweet
8 th	T	Burfi
7 th	R	Ghevar
6 th	Q	Imarti
5 th	U	Kateli
4 th	S	Gujia
3 rd	M	Laddu
2 nd	P	Jalebi
1 st	N	Peda

P > R > M > Q > T > S > N > U
 53 kg 50 kg 46 kg 41 kg 35 kg 34 kg 32 kg 30 kg

S29. Ans.(c)

S30. Ans.(a)

S31. Ans.(c)

S32. Ans.(b)

S33. Ans.(d)

S34. Ans.(e)

Sol.

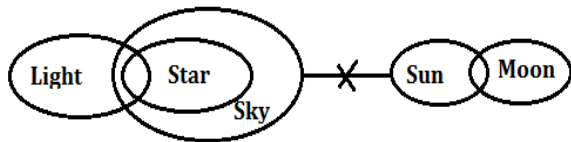

S35. Ans.(d)

Sol.

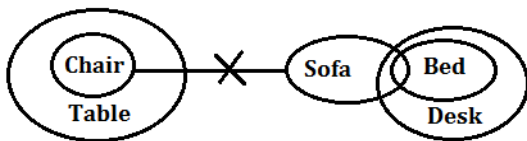

S36. Ans.(d)

Sol.

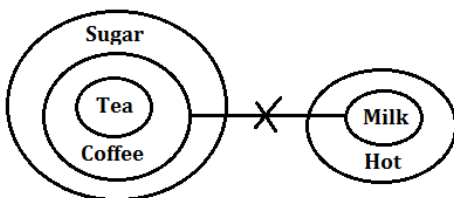

TEST SERIES
Bilingual
VIDEO SOLUTIONS



IBPS CLERK 2020
PRIME

125+ TESTS | eBooks

S37. Ans.(c)

Sol.

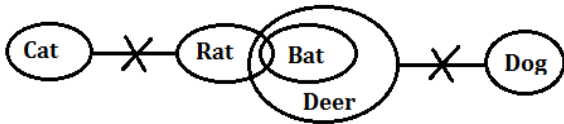

S38. Ans.(e)

Sol. For I: Yes, it nullifies the fact in survey as management is trying to convince that productivity depends upon determination and hard work.

For II: Yes, it nullifies as HR is trying to motivate and trying to keep focus of employee towards only work by encouraging and counseling them.

For III: No, as it is in favor of employee because by getting more casual leave Employee will be able to relax more and can keep them refreshed to work with more enthusiasm.

S39. Ans.(e)

Sol. The conclusion of the argument is that landmark preservation laws deprive landlords of their right to use their own property. (e) comes to grip with this assumption by nothing that a landmark building may not be purely private property and some part of building may belong to the community at large. (a) is not valid as it represents only a partial attack on argument. (b) strengthens the claims that landmark preservation laws represent an unwanted interference with the rights of the landlord.

Solutions (40-44): Only two persons sit between P and the one whose weight is 15. The one who is an immediate neighbor of B faces the one whose weight is 20.

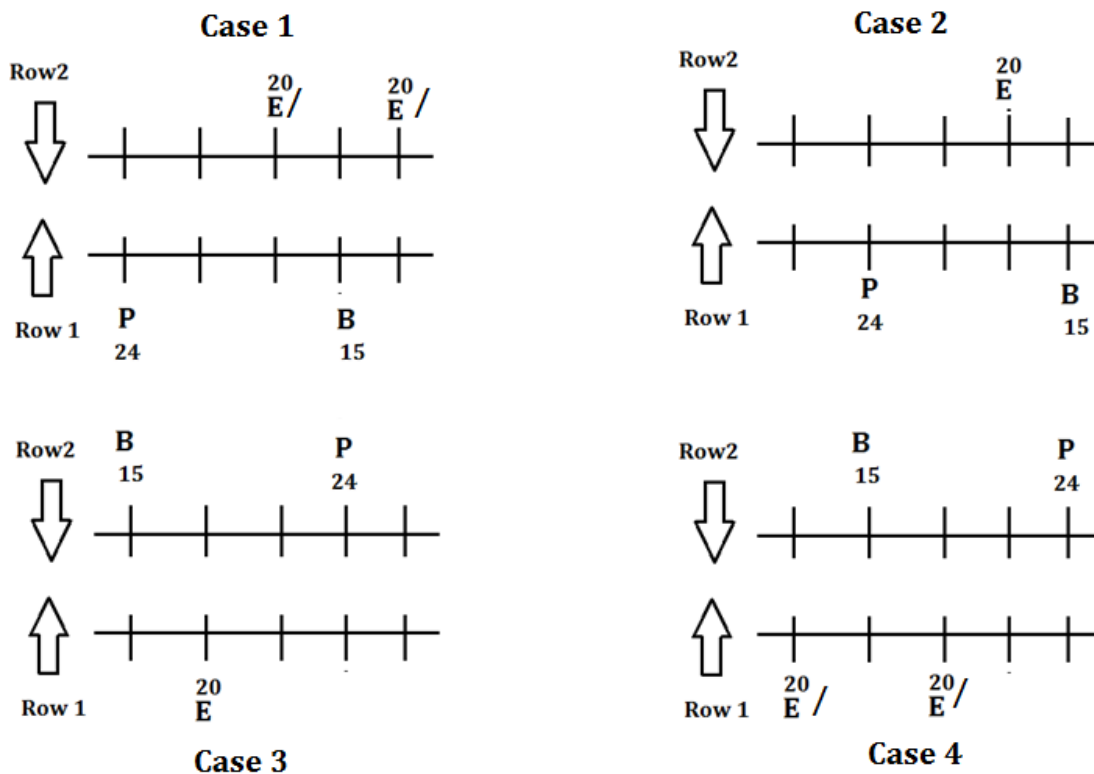

Only one person sit between E and whose weight is 30. From this case 2 and case 3 gets eliminated. A sits 3rd to the right of the one whose weight is 18 and doesn't face P. Only one person sit between R and S.

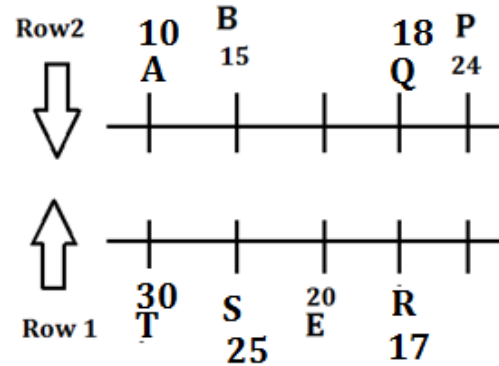
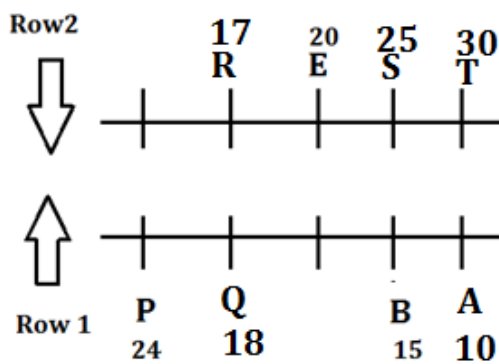

D doesn't sit in row 2. From this case 4 gets eliminated and we get the final solution:

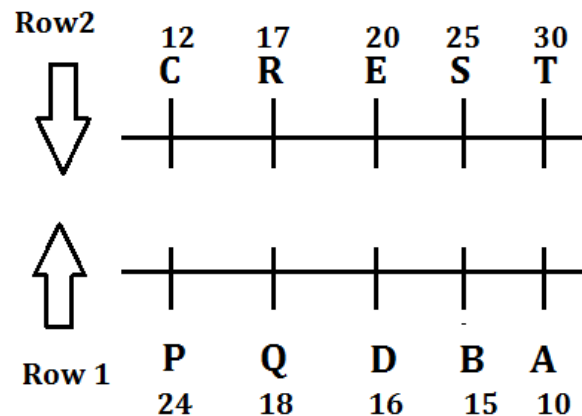

S40. Ans.(d)

S41. Ans.(a)

S42. Ans.(e)

S43. Ans.(e)

S44. Ans.(d)

S45. Ans.(d)

Sol. From the letter E, L, X and D no meaningful word formed.

Solutions (46-50): There are three persons live above the floor of E. Only one person lives between E and the one who likes Toshiba laptop. There are three persons live between the one who likes Toshiba laptop and the one who likes Samsung laptop. From these conditions we have two possible cases. M likes Acer laptop and lives on 2nd floor.

	Case- 1		Case- 2	
Floor	Person	Laptop	Person	Laptop
9				
8		Toshiba		Samsung
7				
6	E		E	
5				
4		Samsung		Toshiba
3				
2	M	Acer	M	Acer
1				

There two persons live between F and the one who likes Lenovo laptop. The one who likes Lenovo laptop lives above the floor of F. By these conditions two more cases added that case- 1a and case- 2a. So new arrangement will be-

	Case- 1		Case- 2		Case- 1a		Case- 2a	
Floor	Person	Laptop	Person	Laptop	Person	Laptop	Person	Laptop
9								
8		Toshiba		Samsung		Toshiba		Samsung
7		Lenovo		Lenovo				
6	E		E		E	Lenovo	E	Lenovo
5								
4	F	Samsung	F	Toshiba		Samsung		Toshiba
3					F		F	
2	M	Acer	M	Acer	M	Acer	M	Acer
1								

K lives immediately above the one who likes Dell laptop. The one who likes Dell laptop lives on an odd numbered floor. By these conditions case- 1 and case- 2 are cancelled. J lives immediately below G. J likes neither Samsung nor Toshiba laptop. So new arrangement will be-

	Case- 1a		Case- 2a	
Floor	Person	Laptop	Person	Laptop
9				
8	G	Toshiba	G	Samsung
7	J		J	
6	E	Lenovo	E	Lenovo
5				
4	K	Samsung	K	Toshiba
3	F	Dell	F	Dell
2	M	Acer	M	Acer
1				

The one who likes HP laptop does not live immediately above or immediately below G. N likes Razer laptop and lives below the one who likes HP laptop. H does not live immediately below E. The one who likes Apple laptop lives below the one who likes Samsung laptop. By this conditions case- 1a is cancelled. So final arrangement will be-

Floor	Person	Laptop
9	H	Asus
8	G	Samsung
7	J	Apple
6	E	Lenovo
5	L	HP
4	K	Toshiba
3	F	Dell
2	M	Acer
1	N	Razer

S46. Ans.(c)

S47. Ans.(d)

S48. Ans.(a)

S49. Ans.(b)

S50. Ans.(e)

S51. Ans.(c)

Sol. Total sold bike in the year 2006

$$= 6000 \times \frac{85}{100} \times \frac{4}{3}$$

$$= 6800$$

Total manufactured bikes in year 2006

$$= \frac{6800}{85} \times 100$$

$$= 8000$$

$$\text{Required difference} = 8000 - 6080 \times \frac{76}{100}$$

$$= 8000 - 6080$$

$$= 1920$$

S52. Ans.(a)

Sol. Total 200 cc bikes sold by Hero in the year 2004

$$= 9000 \times \frac{60}{100} \times \frac{4}{9}$$

$$= 2400$$

$$\text{Required percentage} = \frac{2400}{8000} \times 100 = 30\%$$



BILINGUAL

MAINS CRACKER
All Subjects for Mains exams
(IBPS-PO, RBI ASST., IBPS RRB-PO)
Starts Nov 2, 2020
3:30 PM to 9 PM

S53. Ans.(e)**Sol.** Total sold bikes in 2001

$$= 6500 \times \frac{78}{100} = 5070$$

Total sold bikes in 2003

$$= 7500 \times \frac{80}{100} = 6000$$

Total sold bikes in 2005

$$= 6000 \times \frac{85}{100} = 5100$$

$$\text{Required average} = \frac{5070+6000+5100}{3}$$

$$= \frac{16170}{3} = 5390$$

S54. Ans.(c)**Sol.** Total unsold bikes in the year 2001 and 2002

$$= 6500 \times \frac{22}{100} + \frac{24}{100} \times 8000$$

$$= 1430 + 1920$$

$$= 3350$$

Total unsold bikes in the year 2004

$$= 9000 \times \frac{40}{100}$$

$$= 3600$$

$$\text{Required percentage} = \frac{3600-3350}{3600} \times 100$$

$$= \frac{250}{36}$$

$$= 6\frac{17}{18}\%$$

**S55. Ans.(d)****Sol.** Total manufactured bikes in the year 2000

$$= 6500 \times \frac{(100-12)}{100}$$

$$= 5720$$

Total sold bikes in the year 2000

$$= 6500 \times \frac{78}{100} + 130$$

$$= 5200$$

Total unsold bikes in the year 2000

$$= 5720 - 5200$$

$$= 520$$

Total unsold bikes in the year 2005

$$= 6000 \times \frac{15}{100}$$

$$= 900$$

$$\text{Required ratio} = \frac{520}{900} = 26 : 45$$

S56. Ans.(c)**Sol.** Total volume of two cylindrical vessel = $\pi r_1^2 h_1 + \pi r_2^2 h_2$

$$= \frac{22}{7} [(4 \times 4 \times 6) + (5 \times 5 \times 4)]$$

$$= \frac{22}{7} (96 + 100)$$

$$= 616 \text{ cm}^3$$

Let the radius of disc be r cm

ATQ -

$$\pi r^2 h = 616 \text{ cm}^3$$

$$\frac{22}{7} \times r^2 \times 1 = 616$$

$$r^2 = \frac{616 \times 7}{22}$$

$$r = 14 \text{ cm}$$

S57. Ans.(a)**Sol.** Initial ratio of HCL and H_2SO_4 in mixture = $18 : 10 = 9 : 5$

ATQ-

$$\frac{18 - \frac{9X}{14}}{10 - \frac{5X}{14} + (X - 4.6)} = \frac{7}{6}$$

$$6(252 - 9X) = 7(75.6 + 9X)$$

$$117X = 1512 - 529.2$$

$$117X = 982.8$$

$$X = \frac{982.8}{117}$$

$$X = 8.4 \text{ l}$$

 H_2SO_4 added by man

$$= (8.4 - 4.6)$$

$$= 3.8 \text{ l}$$

**S58. Ans.(b)****Sol.** Downstream speed of boat = $(6 + 9) = 15 \text{ km/hr}$ Upstream speed of boat = $(9 - 6) = 3 \text{ km/hr}$ Let distance between X to Y is D km and between Y to Z is $\frac{D}{2} \text{ km}$

ATQ -

$$\frac{D}{15} + \frac{D}{6} = 28$$

$$\frac{7D}{30} = 28$$

$$D = 120 \text{ km}$$

Total distance covered by boat from point X to point Z = $\frac{120}{2} = 60 \text{ km}$

S59. Ans.(e)**Sol.** Probability for ball being red from bag A

$$= \frac{1}{2} \times \frac{x}{x+5}$$

Probability for ball being red from bag B

$$= \frac{1}{2} \times \frac{8}{x+8}$$

$$\Rightarrow \frac{1}{2} \left[\frac{x}{x+5} + \frac{8}{x+8} \right] = \frac{5}{9}$$

$$\frac{10}{9} = \frac{x(x+8)+8(x+5)}{(x+8)(x+5)}$$

$$\frac{10}{9} = \frac{x^2+8x+8x+40}{x^2+13x+40}$$

$$10x^2 + 130x + 400 = 9x^2 + 144x + 360$$

$$x^2 - 14x + 40 = 0$$

$$x^2 - 10x - 4x + 40 = 0$$

$$x(x - 10) - 4(x - 10) = 0$$

$$x = 10, 4$$

S60. Ans.(e)

Sol. Speed of train = $\frac{480-360}{(T+4)-T}$

$$= \frac{120}{4} = 30 \text{ km/hr}$$

Speed of bus = $\frac{30}{6} \times 5 = 25 \text{ km/hr}$

Required time = $\frac{800}{30+25} = \frac{800}{55}$ hour

$$= 14 \frac{6}{11} \text{ hours}$$

**S61. Ans.(c)****Sol.** Let initial quantity of milk and water in the mixture be 7y and xy respectively

So,

$$\frac{7y}{xy+20} = \frac{7}{15}$$

$$105y = 7xy + 140 \dots(i)$$

and

$$\frac{7y}{xy+10} = \frac{14}{25}$$

$$175y = 14xy + 140 \dots(ii)$$

Solving (i) and (ii)

$$y = 4$$

Initial quantity of milk in mixture = $7y = 28 \text{ L}$

NRA-CET Ready**BANK
MAHA PACK**Live Class, Video Course,
Test Series, eBooks**Bilingual (with eBooks)
12+12 Months Validity**

S62. Ans.(b)

Sol. Let veer can do $(x - 4)$ unit of work in one day

And Ayush can do $(x + 4)$ unit of work in one day

So,

$$(x - 4) \times 5 = (x + 4) \times 3$$

$$5x - 20 = 3x + 12$$

$$2x = 32$$

$$x = 16$$

S63. Ans.(e)

Sol. ATQ,

$$P \left(1 + \frac{18}{100}\right)^2 = 83544$$

$$P = \text{Rs } 60000$$

And,

$$\frac{(P+X) \times 20 \times 2}{100} = 30000 \quad \dots(i)$$

Put value of P in (i):

$$\frac{(60000+X) \times 20 \times 2}{100} = 30000$$

$$60000 + X = 75000$$

$$X = \text{Rs } 15000$$

S64. Ans.(d)

Sol. Ratio of cost price of bat to that of ball

Given, 2bats = 6 balls

1 bat of 3 balls

Bat : ball = 3 : 1

Let cost price of one bat and one ball be $3a$ & a respectively.

$$\text{So, selling price of 1 bat} = 3a \times \frac{140}{100}$$

$$= \text{Rs } 4.2a$$

$$\text{And, selling price of 1 ball} = a \times \frac{150}{100}$$

$$= \text{Rs } 1.5a$$

Now, let number of bats and balls sold by shopkeeper be $2b$ & $3b$ respectively.

$$\text{Total cost price for shopkeeper} = (2b \times 3a) + (3b \times a)$$

$$= \text{Rs. } 9ab$$

$$\text{Total selling price for shopkeeper} = (2b \times 4.2a) + (3b \times 1.5a)$$

$$= \text{Rs. } 12.9ab$$

$$\text{Required \%} = \frac{12.9ab - 9ab}{9ab} \times 100$$

$$= 43\frac{1}{3}\%$$

S65. Ans.(e)

Sol. Let A invested at the rate of R%

So, interest received by A after three years = $2400 \times \frac{R}{100} \times 3 = 72R$ Rs.

And, let B invested Rs. P

Equivalent CI for two years at the rate 20% = $20 + 20 + \frac{20 \times 20}{100} = 44\%$

So, interest received by B after two years = $P \times \frac{44}{100} = 0.44P$ Rs.

Given, $72R : 0.44P = 9 : 11$

$P = 200R$ ----- (i)

Only (a) & (d) satisfied the equation (i)

S66. Ans.(e)

Sol. I. $27x^2 - 60x + 32 = 0$

$$27x^2 - 36x - 24x + 32 = 0$$

$$9x(3x-4) - 8(3x-4) = 0$$

$$(3x-4)(9x-8) = 0$$

$$x = \frac{4}{3}, \frac{8}{9}$$

II. $24y^2 - 53y + 28 = 0$

$$24y^2 - 32y - 21y + 28 = 0$$

$$8y(3y-4) - 7(3y-4) = 0$$

$$(3y-4)(8y-7) = 0$$

$$y = \frac{4}{3}, \frac{7}{8}$$

So, no relation.

**S67. Ans.(c)**

Sol. I. $(x-7)^2 = 1$

$$x - 7 = \pm 1$$

$x-7 = 1$	$x-7 = -1$
$x = 8$	$x = 6$

II. $(y-9)^2 = y(1-y) + 39$

$$y^2 + 81 - 18y = y - y^2 + 39$$

$$\Rightarrow y^2 - 19y + 42 = 0$$

$$2y^2 - 12y - 7y + 42 = 0$$

$$2y(y-6) - 7(y-6) = 0$$

$$(y-6)(2y-7) = 0$$

$$y = 6, \frac{7}{2}$$

So, $x \geq y$

S68. Ans.(b)

Sol. I. $15x^2+46x+35 = 0$

$15x^2+25x+21x+35 = 0$

$5x(3x+5) + 7(3x+5) = 0$

$(3x+5) (5x+7) = 0$

$x = \frac{-5}{3}, \frac{-7}{5}$

II. $24y^2+59y+36 = 0$

$24y^2+32y+27y+36 = 0$

$8y (3y + 4) + 9(3y+4) = 0$

$(3y+4) (8y+9) = 0$

$y = \frac{-4}{3}, \frac{-9}{8}$

So, $x < y$.

S69. Ans.(a)

Sol. I. $(x-3)^2+(x-5)^2 = x(x-4)-1$

$x^2+9-6x+x^2+25-10x = x^2-4x-1$

$\Rightarrow x^2-12x+35 = 0$

$x^2-7x-5x+35 = 0$

$x(x-7) -5(x-7) = 0$

$(x-7) (x-5) = 0$

$x = 5, 7$

II. $6y^2-53y+117 = 0$

$6y^2-27y-26y+117 = 0$

$3y(2y-9) - 13(2y-9) = 0$

$(2y-9) (3y-13) = 0$

$y = \frac{9}{2}, \frac{13}{3}$

So, $x > y$.

S70. Ans.(e)

Sol. I. $20x^2-61x+45 = 0$

$20x^2-25x-36x+45 = 0$

$5x(4x-5)-9(4x-5) = 0$

$(4x-5) (5x-9) = 0$

$x = \frac{5}{4}, \frac{9}{5}$

II. $8y^2-26y+21 = 0$

$8y^2-12y-14y+21 = 0$

$4y(2y-3) -7(2y-3) = 0$

$(2y-3) (4y-7) = 0$

$y = \frac{3}{2}, \frac{7}{4}$

So, no relation.

**NRA-CET Ready****BANK**

Useful for Bank & Insurance Exams

TEST PACK**12 Months Subscription**

S71. Ans.(d)**Sol.** Diesel vehicles manufactured by A & Petrol vehicles manufactured by B together

$$= 800 \times \frac{40}{100} + 960 \times \frac{25}{100}$$

$$= 320 + 240$$

$$= 560$$

$$\text{Diesel vehicles manufactured by D} = 840 \times \frac{50}{100} = 420$$

$$\text{Required percentage} = \frac{560-420}{420} \times 100$$

$$= \frac{140}{420} \times 100$$

$$= 33\frac{1}{3}\%$$

S72. Ans.(e)

$$\text{Sol. CNG vehicles manufactured by C \& D together} = 1020 \times \frac{100-(30+40)}{100} + 840 \times \frac{100-(25+50)}{100}$$

$$= 306 + 210 = 516$$

$$\text{Diesel vehicles manufactured by A \& B together} = 800 \times \frac{20}{100} + 960 \times \frac{25}{100}$$

$$= 160 + 240 = 400$$

$$\text{Required ratio} = 516 : 400 = 129 : 100$$

S73. Ans.(a)

$$\text{Sol. Diesel vehicles manufactured by E} = 400 \times 3 - \left[960 \times \frac{45}{100} + 1020 \times \frac{40}{100} \right]$$

$$= 1200 - (432 + 408)$$

$$= 1200 - 840 = 360$$

$$\text{CNG vehicles manufactured by E} = 360 \times \frac{5}{9} = 200$$

$$\text{Petrol vehicles manufactured by E} = 1040 - (360 + 200) = 480$$

S74. Ans.(d)

$$\text{Sol. CNG vehicles manufactured by B} = 960 \times \frac{100-(25+45)}{100} = 288$$

$$\text{CNG vehicles manufactured by D} = 840 \times \frac{100-(25+50)}{100} = 210$$

$$\text{Required percentage} = \frac{288-210}{210} \times 100$$

$$= \frac{78}{210} \times 100 = 37\frac{1}{7}\%$$

S75. Ans.(c)

$$\text{Sol. Petrol vehicles manufactured by B} = 960 \times \frac{25}{100} = 240$$

$$\text{Petrol vehicles manufactured by C} = 1020 \times \frac{30}{100} = 306$$

$$\text{Petrol vehicles manufactured by D} = 840 \times \frac{25}{100} = 210$$

$$\text{Total Petrol vehicles manufactured by B, C \& D} = (240 + 306 + 210) = 756$$

$$\text{Required average} = \frac{756}{3} = 252$$

S76. Ans.(c)

Sol. Let length of train be L meters and speed of train be S km/hr

$$\text{From statement 1, } L + 540 = S \times \frac{5}{18} \times 90$$

$$L = 25S - 540 \quad \dots (1)$$

$$\text{From statement 2, } L = (S - 6) \times \frac{5}{18} \times 43.2$$

$$L = (S - 6) \times 12 \quad \dots (2)$$

From (1) and (2), we get

$$25S - 540 = (S - 6) \times 12$$

$$25S - 540 = 12S - 72$$

$$25S - 12S = 540 - 72$$

$$13S = 468$$

$$S = 36 \text{ km/hr}$$

So, both the statements taken together are necessary to answer the question, but neither of the statements alone is sufficient to answer the question.

S77. Ans.(a)

Sol. From statement 1: Let denominator of fraction be p

$$\text{Fraction} = \frac{\left(\frac{p \times 60}{100}\right)}{p}$$

$$\text{Fraction} = \frac{6}{10} = \frac{3}{5}$$

$$\text{Reqd value} = \frac{40}{100} \times \frac{6}{10} = \frac{24}{100} = \frac{6}{25}$$

From statement 2:

$$\text{Fraction} = \frac{p-4}{p}$$

Required value can't be determined

Hence, statement **(1)** alone is sufficient to answer the question but statement **(2)** alone is not sufficient to answer the question.

S78. Ans.(c)

Sol. Perimeter of a semi-circle = $\pi r + 2r$

From statement 1 and statement 2

$$\text{Side of the square} = \sqrt{3136} = 56 \text{ cm}$$

$$\text{Radius} = \frac{56}{2} = 28 \text{ cm}$$

$$\text{Perimeter of the semicircle} = \left(\frac{22}{7} \times 28 + 2 \times 28\right) \text{ cm}$$

$$= 88 + 56 = 144 \text{ cm}$$

Hence, both the statements taken together are necessary to answer the question, but neither of the statements alone is sufficient to answer the question.

S79. Ans.(e)**Sol.** From statement 1:

$$\text{Required number of men}(p) = \frac{30 \times 80}{60} = 40$$

From statement 2: According to the question

$$p \times 60 = (p+8) \times 50$$

$$60p = 50p + 400$$

$$10p = 400$$

$$P = 40$$

Hence, either statement **(1)** or statement **(2)** by itself is sufficient to answer the question.**S80. Ans.(c)****Sol.** Let speed of boat in still water is x km/hr and speed of stream = y km/hrFrom statement 1: $x = y + 12$

$$\text{And from statement 2: } \frac{90}{x+y} + \frac{90}{x-y} = 10$$

From (1) and (2), we get

$$\frac{90}{(y+12+y)} + \frac{60}{y+12-y} = 10$$

$$\frac{90}{2y+12} + \frac{60}{12} = 10$$

$$\frac{90}{2y+12} = 5$$

$$y = \frac{6}{2} = 3 \text{ km/hr}$$

$$x = 12 + 3 = 15 \text{ km/hr}$$

$$\text{Required ratio} = \frac{96}{15-3} : \frac{90}{15}$$

$$= \frac{96}{12} : \frac{90}{15}$$

$$= 8:6$$

$$= 4:3$$

So, both the statements taken together are necessary to answer the question, but neither of the statements alone is sufficient to answer the question.

S81. Ans.(d)

$$\text{Sol. Total students in A} = 200 \times \frac{20}{100} = 40$$

$$\text{Total students in C} = 200 \times \frac{22.5}{100} = 45$$

$$\text{Difference between girls and boys in A} = 50 \times \frac{20}{100} = 10$$

$$\text{Difference between girls and boys in C} = 50 \times \frac{10}{100} = 5$$

Let total number of girls in A = x So, total number of boys in A = $(40 - x)$ And let total number of girls in C = y Total number of boys in C = $(45 - y)$ 

TEST SERIES

Bilingual

Video Solutions

RBI ASSISTANT

MAINS

25 Total Tests | eBooks

$$\text{Given, } (40 - x) - x = 10$$

$$2x = 30$$

$$x = 15$$

$$\text{Similarly, } (45 - y) - y = 5$$

$$2y = 40$$

$$y = 20$$

$$\text{Required probability} = \frac{25}{40} \times \frac{25}{45} = \frac{25}{72}$$

S82. Ans.(b)

Sol. All five students from each B & D chosen for representing their respective school in a debate competition should be boys and number of girls should be greater than number of boys in order to maximize the probability of girls in remaining students.

$$\text{Total number of students in B} = 200 \times \frac{15}{100} = 30$$

$$\text{Total number of students in D} = 200 \times \frac{25}{100} = 50$$

$$\text{Difference between boys and girls in B} = 50 \times \frac{20}{100} = 10$$

$$\text{Difference between boys and girls in D} = 50 \times \frac{20}{100} = 10$$

Let total number of boys in B = a

So, total number of girls in B = (30 - a)

Let total number of boys in D = b

So, total number of girls in D = (50 - b)

ATQ,

$$(30 - a) - a = 10$$

$$a = 10$$

$$\text{Also, } (50 - b) - b = 10$$

$$b = 20$$

$$\text{Required probability} = \frac{20}{25} \times \frac{30}{45} = \frac{8}{15}$$

S83. Ans.(a)

$$\text{Sol. Total students in E} = 200 \times \frac{17.5}{100} = 35$$

$$\text{Difference between girls and boys in E} = 50 \times \frac{30}{100} = 15$$

Let number of girls in E = p

So, number of boys in E = (35 - p)

$$\text{Given, } (35 - p) - p = 15$$

$$p = 10$$

$$\text{Number of boys in F} = (35 - 10) - 5 = 20$$

And number of girls in F = 10

$$\text{Required probability} = \frac{20 \times 10}{{}^{30}C_2} = \frac{40}{87}$$



S84. Ans.(d)

Sol. Total number of students in A = $200 \times \frac{20}{100} = 40$

Difference between girls and boys in A = $50 \times \frac{20}{100} = 10$

Let total number of girls in A = x

So, total number of boys in A = (40 - x)

ATQ,

$$(40 - x) - x = 10$$

$$2x = 30$$

$$x = 15$$

Let total number of boys who left school A = a

And let, total number of girls left school A = 2a

Now,

$$\frac{{}^{25-a}C_2 + {}^{15-2a}C_2}{{}^{40-3a}C_2} = \frac{11}{18}$$

$$a = 4$$

$$\text{Required difference} = 2a - a = a = 4$$

S85. Ans.(b)

Sol. Pattern of series -

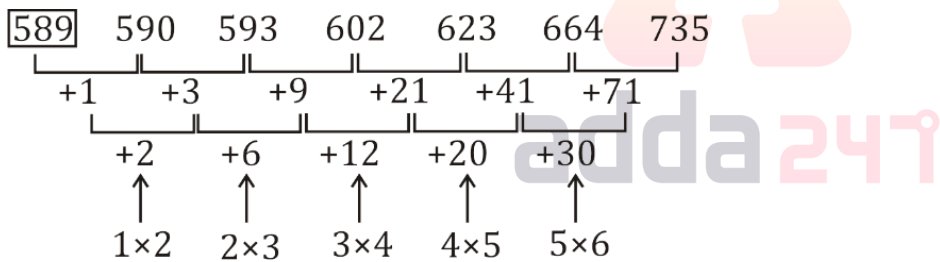
**S86. Ans.(d)**

Sol. Pattern of series -

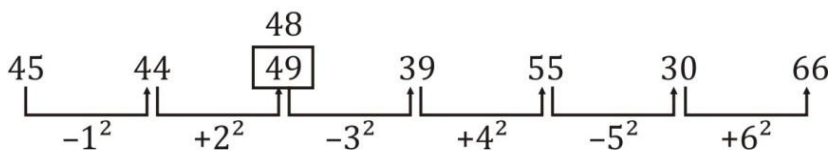
**S87. Ans.(c)**

Sol. Pattern of series -

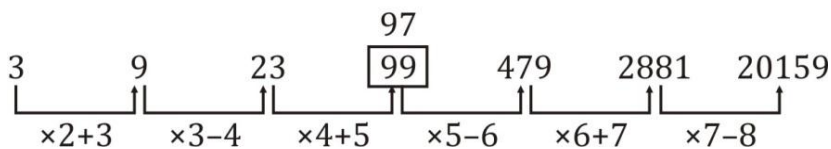

S88. Ans.(a)

Sol. Pattern of series -

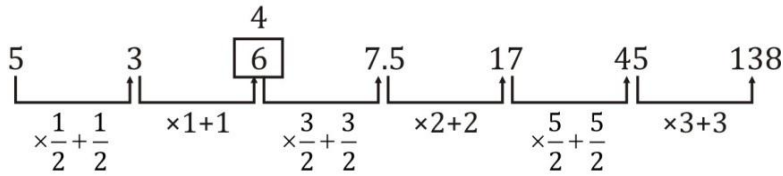

S89. Ans.(e)

Sol. Pattern of series -

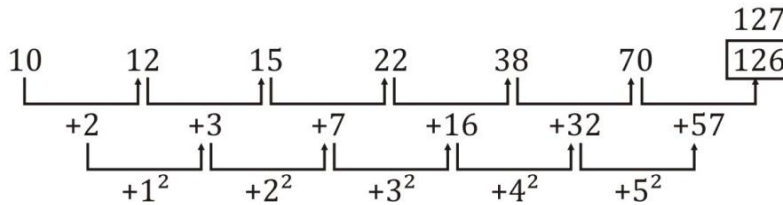

S90. Ans.(b)

Sol. Pattern of series -

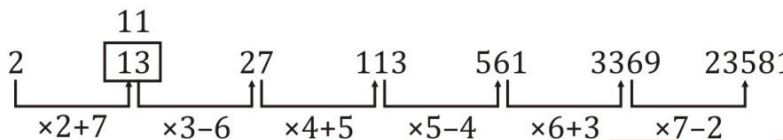

Solutions (91-95):

Ratio of profit share

Arun	Veer
60000×15	90000×8
5	4

Let the profit share of Arun & Veer be Rs. 5x & Rs. 4x respectively.

ATQ, $x = 10000$

Profit share of Arun = Rs. 50,000

Profit share of Veer = Rs. 40,000

Amount received by Arun at the end of 1.5 years at 20% p.a CI = Rs. 66,000

Amount received by Veer at the end of 2 years at 15% p.a SI = Rs. 52,000

Cost price of bike = Rs. 66,000

Selling price of bike = Rs. $66,000 \times 0.95$ = Rs. 62,700

Cost price of laptop L_1 = Rs. 26,000

Cost price of laptop L_2 = Rs. 26,000

Selling price of laptop L_1 = Rs. 28,600

Selling price of laptop L_2 = Rs. 29,900

TEST SERIES

Bilingual

VIDEO SOLUTIONS



IBPS CLERK 2020

PRIME

125+ TESTS | eBooks

S91. Ans.(b)

Sol. Profit earned by Veer on selling both laptops = $(28600 + 29900 - 52000) = \text{Rs. } 6500$

Required interest received = $\frac{6500 \times 4 \times 10}{100} = \text{Rs. } 2600$

S92. Ans.(a)

Sol. Price of a bike after two years. = $66000 \left(1 - \frac{15}{100}\right)^2 = \text{Rs. } 47,685$

S93. Ans.(d)

Sol. Marked price of laptop $L_1 = 26000 \times 1.4 = \text{Rs. } 36,400$

New selling price = $\text{Rs. } 28600 + \text{Rs. } 2600 = \text{Rs. } 31,200$

Then discount % = $\frac{36400 - 31200}{36400} \times 100 = \frac{5200}{36400} \times 100 = 14\frac{2}{7}\%$

S94. Ans.(c)

Sol. Total selling price of all the three items

= $\text{Rs. } (62,700 + 28,600 + 29,900)$

= $\text{Rs. } 1,21,200$

Total cost price of all the items = $\text{Rs. } (66,000 + 52,000)$

= $\text{Rs. } 1,18,000$

108% of total CP = $\text{Rs. } 1,27,440$

Required difference = $\text{Rs. } 6240$

S95. Ans.(b)

Sol. Current net profit on all the items together

= $(62700 + 28600 + 29900) - (66000 + 52000)$

= $\text{Rs. } 3200$

Let the profit share of Arun and Veer be $\text{Rs. } 5x$ & $\text{Rs. } 4x$ respectively.

ATQ,

$x = 11000$

Profit share of Arun = $\text{Rs. } 55,000$

Profit share of Veer = $\text{Rs. } 44,000$

Amount received by Arun at the end of 1.5 yr = $\text{Rs. } 72,600$.

Selling price of bike = $\text{Rs. } 72,600 \times 0.95 = \text{Rs. } 68,970$

Amount received by Veer at the end of 2 years = $\text{Rs. } 57,200$

Cost price of laptop $L_1 = \text{Rs. } 28,600$

Selling price of laptop $L_1 = \text{Rs. } 31,460$

Cost price of laptop $L_2 = \text{Rs. } 28,600$

Selling price of laptop $L_2 = \text{Rs. } 32,890$

New net profit = $(68970 + 31460 + 32890) - (72600 + 57200)$

= $\text{Rs. } 3520$

Required changes = $\text{Rs. } (3520 - 3200)$

= $\text{Rs. } 320$

S96. Ans.(b)**Sol.** Let total cost price $\Rightarrow 100x$ Selling price $\Rightarrow 120x$ 2nd selling price $\Rightarrow 70x + \frac{30x \times 150}{100}$

$$= 115x \times \frac{120}{100} = 138x$$

Now,

$$138x - 120x = 450$$

$$18x = 450$$

$$x = 25 \text{ Rs.}$$

$$\text{Cost of packaging} = 25 \times 20 = 500 \text{ Rs}$$

S97. Ans.(d)**Sol.** If B invested Rs. 'x' then A invested Rs. 1.25x

Ratio of profit share A and B according to their investment

$$1.25x : x \rightarrow 5 : 4$$

If total profit = 100y

$$\text{A's profit} = 15y + 85y \times \frac{5}{9} = 9520$$

$$135y + 425y = 9520 \times 9$$

$$y = \frac{9520 \times 9}{560} = 153$$

$$\text{Total profit earned by them} = 100 \times 153 = 15,300$$

**S98. Ans.(b)**

$$\text{Sol. } (X - 4) \times 5 = (X + 5) \times 4$$

$$5X - 20 = 4X + 20$$

$$X = 40$$

$$(Y - 15) \times 6 = (Y + 15) \times 3$$

$$2Y - 30 = Y + 15$$

$$Y = 45$$

Quantity II > Quantity I

S99. Ans.(e)**Sol.** Ratio of profit share of A and B

$$\frac{x \times 8}{5} : \frac{x \times 1.6 \times 9}{9}$$

$$\text{Quantity I: A's profit} = 25,200 \times \frac{5}{14} = 9000$$

$$\text{Quantity II: B's profit} = 14,000 \times \frac{9}{14} = 9000$$

Quantity I = Quantity II

S100. Ans.(e)**Sol.** ATQ,

$$\frac{X \times 20 \times 2}{100} + X \left[1 + \frac{10}{100} \right]^2 - X = 4880$$

$$\frac{40X}{100} + \frac{21X}{100} = 4880$$

$$\frac{61X}{100} = 4880$$

$$\Rightarrow X = 8000$$

$$\text{Quantity I: } 8000 + 2000 = 10,000$$

$$\text{Quantity II: } 8000 \times \frac{125}{100} = 10,000$$

$$\text{Quantity I} = \text{Quantity II}$$

S101. Ans.(b)

Sol. Going through the given passage it can be clearly seen that author is bolstering current government by highlighting its achievements. So, from the given options, option (a) and (c) are in accordance with the given idea whereas option (b) is not. Also, option (d) is neutral. Hence, the correct answer choice would be option (b)

S102. Ans.(a)

Sol. Bedevilled means cause great and continual trouble to.

Afflict means cause pain or trouble to; affect adversely.

Cabal means a secret political clique or faction.

Hummock means a hillock or knoll.

Immure means enclose or confine (someone) against their will.

Going through the meaning of the given words it can be clearly seen that the appropriate answer choice would be option (a)

S103. Ans.(d)

Sol. From the given questions, only (d) can be answered after reading the given passage. And answer to the question asked in option (d) can be found in last two lines of the second paragraph. Also, there are facts presented in support of the improvement in the area of primary employment but reason for the given improvement is not mentioned. Hence, the correct answer choice would be option (d)

S104. Ans.(d)

Sol. Here Tamed is used a verb which means make less powerful and easier to control.

Vanquish means defeat thoroughly

Mitigate means make (something bad) less severe, serious, or painful.

Fierce means having or displaying an intense or ferocious aggressiveness.

Instigate means bring about or initiate (an action or event).

So going through the meaning of the given words it can be clearly seen that the correct answer choice would be option (d)



BILINGUAL

MAINS CRACKER

All Subjects for Mains exams

(IBPS-PO, RBI ASST., IBPS RRB-PO)

Starts Nov 2, 2020

3:30 PM to 9 PM

S105. Ans.(b)

Sol. In the given statement speaker is implying that lack of trust among people is the main reason for the current economic situation. Same thing is said in option (b) and hence the correct answer choice.

S106. Ans.(c)

Sol. From the given options, option (c) is not true as per Fabian's observations. Evidence in support of the given argument can be found in the second paragraph of the given passage in which it is stated that '*as intergalactic gas cools, the cooler gas shrinks inward toward the center of the galaxy. Meanwhile its place is taken by hotter intergalactic gas from farther out on the edge of the galaxy*' here it is mentioned that cooler gas is replaced with gas on outer edge of galaxy, not from different galaxy. Hence, the correct answer choice would be option (c)

S107. Ans.(b)

Sol. From the beginning of the passage, author has argued with absence of matter in space and supported this argument with various facts and incidents. So, from the given options most appropriate answer choice would be option (b)

S108. Ans.(d)

Sol. After reading the passage we can get an idea that the cold gases flows toward the center of the galaxy. So, in accordance with the passage, appropriate filler for the given blank would be 'falling'. Hence, the correct answer choice would be option (d)

S109. Ans.(c)

Sol. From the given statements, only option (c) is correct and evidence in support of the given argument can be found in the first paragraph of the given passage in which it is stated that '*The gas apparently condenses into a collection of small stars, each a little larger than the planet Jupiter.*' Hence, the correct answer choice would be option (c)

S110. Ans.(a)

Sol. From the given options, option (a) is the most appropriate answer choice and evidence in support of the given argument can be found in the first paragraph of the given passage in which it is stated that '*astronomers who believe that a heavy "rain" of gas is falling into many galaxies from the supposedly empty space around them.*' From given statement option (a) can be inferred clearly and hence, the correct answer choice.

S111. Ans.(c)

Sol. Infer means deduce or conclude

Knave means a dishonest or unscrupulous man.

Prompt means cause or bring about

Intervene means take part in something so as to prevent or alter a result or course of events

Going through the meaning of the given words it can be clearly seen that the appropriate filler for the given blank would be option (c)

S112. Ans.(b)

Sol. In the given sentence, 'Sciences' at its current is incorrect because it is making the given sentence grammatically incorrect as can be seen from the helping following it. But interchanging it with 'Challenge' will make the given sentence both grammatically and contextually correct. Hence, the correct answer choice would be option (b)

S113. Ans.(c)

Sol. Indignation means anger or annoyance provoked by what is perceived as unfair treatment.

Latent means existing but not yet developed or manifest

Optimum means most conducive to a favourable outcome

Vexation means the state of being annoyed, frustrated, or worried.

Corpulent means fat.

So, going through the meaning of the given words it can be clearly seen that the most appropriate answer choice would be option (c)

S114. Ans.(d)

Sol. Evidence in support of the given argument can be found in the third paragraph of the given passage in which it is stated that, *'There is no denying that serious empirical research has helped make economics the important discipline that.....the biggest breakthroughs in economic theory have occurred during times of great turmoil.'* From the given statement both (i) and (iii) option can be inferred clearly. Hence, the correct answer choice would be option (d)

S115. Ans.(d)

Sol. Seminal means strongly influencing later developments. All of the given options except option (d) are synonym of the given word. Option (d) i.e. impertinent which means not pertinent to a particular matter; irrelevant, is antonym of the given word. Hence, the correct answer choice would be option (d)

S116. Ans.(c)

Sol. Both Trivial and Paltry are synonym to each other which means of little value or importance. So, from the given sentences, blanks in (A) and (B) can be filled with the given words. Also, given words can grammatically fit the blank in (C) but it will make the given sentence contextually incorrect. Hence, the correct answer choice would be option (c)

S117. Ans.(b)

Sol. Leaves can mean either go away from or part of the plant

Defile means damage the purity or appearance of or a steep-sided narrow gorge or passage

So from the given options, blank in sentence (B) can be filled with both the given words to make it grammatically and contextually correct. However, such condition cannot be met in the other two sentences. Hence, the correct answer choice is option (b)

S118. Ans.(e)

Sol. Both Avail and Aid means to help. So, all the blanks can be filled with the given words to make them grammatically and contextually correct. Hence, the correct answer choice would be option (e)

S119. Ans.(c)**Sol.** Engage means occupy or attract

Captivate means attract and hold the interest and attention of.

So, from the given sentences blanks of both (A) and (B) can be filled with the given words without altering their meaning and making them grammatically correct. Captivate will not fit the blank of the third sentence as can be seen from the usage of 'with' after the blank. Hence, the correct answer choice would be option (c)

S120. Ans.(e)**Sol.** Elegant means pleasingly ingenious and simple.

So, from the given sentences, all the given blanks can be filled with the given words. Hence, the correct answer choice would be option (e)

S121. Ans.(e)**Sol.** Here, the given paragraph mentions about the possible focus areas to improve agro-produce and movement. Here, All the options are at the correct places. Hence, option (e) is the most suitable answer choice.

Impediments: an impairment (such as a stutter or a lisp) that interferes with the proper articulation of speech

Protracted: lasting for a long time or longer than expected or usual.

Dillydally: to waste time by loitering or delaying

Entrenchments: the process or fact of an attitude, habit, or belief becoming so firmly established that change is very difficult or unlikely.

S122. Ans.(c)**Sol.** Here, the given paragraph talks about the timeline of the legal proceedings against Parvez Musharraf and his final conviction. Here, "valour" and "honoured" make the statement grammatically incorrect thus will be replaced with "treason" and "indicted" respectively. Hence, option (c) is the most suitable answer choice.

valour: great courage in the face of danger

treason: the crime of betraying one's country, especially by attempting to kill or overthrow the sovereign or government.

Indicted: formally accuse of or charge with a crime

Bewildered: confused; very puzzled.

S123. Ans.(d)**Sol.** Here, the given paragraph talks about a law which has been enacted and the effect it has had on the society. Here, "hallowed", "freezing" and "celebration" make the statement grammatically incorrect thus will be replaced with "contentious", "simmering", "legislation" respectively. Hence, option (d) is the most suitable answer choice.

Contentious: giving rise or likely to give rise to controversy or public disagreement.

Simmering: be angry

Legislation: the preparing and enacting of laws by local, state, or national legislatures.

Hallowed: something which is holy

NRA-CET Ready**BANK
MAHA PACK**Live Class, Video Course,
Test Series, eBooks**Bilingual (with eBooks)
12+12 Months Validity**

S124. Ans.(c)

Sol. Here, the given paragraph talks about a fire tragedy which took place in an illegal residential cum production unit and the fatalities inflicted as a result. Here, “embezzled” and “spacious” make the statement grammatically incorrect thus will be replaced with “engulfed” and “congested” respectively.

Hence, option (c) is the most suitable answer choice.

embezzled: steal or misappropriate

precarity: not securely held or in position; dangerously likely to fall or collapse.

Solitude: the state or situation of being alone.

Engulfed: sweep over (something) so as to surround or cover it completely

S125. Ans.(d)

Sol. Here, the given paragraph talks about the alien aquatic species which enter into different water bodies during heavy rains. Here, “personified” and “hardy” make the statement contextually incorrect thus will be replaced with “invasive” and “fragile” respectively. Hence, option (d) is the most suitable answer choice.

Personified: represent (a quality or concept) by a figure in human form

hardy: capable of enduring difficult conditions;

invasive: tending to spread very quickly and undesirably or harmfully.

autonomy: condition of self-government.

fragile: easily broken or damaged

S126. Ans.(b)

Sol. Here, the given paragraph talks about a convict and the judge’s reaction toward him due to the quantum of his crimes. Here “continuously” makes the statement contextually incorrect thus will be replaced with “intermittently” Hence, option (b) is the most suitable answer choice.

probation: in criminal law is a period of supervision over an offender, ordered by the court instead of serving time in prison.

belittling: dismissive of the importance of a person or thing

reconciliation: the restoration of friendly relations.

intermittently: at irregular intervals; not continuously or steadily.

S127. Ans.(a)

Sol. In the third part of the sentence “were” will be replaced by the word “was” because there are various pronouns like “Everybody, Anybody, Anything, Any, Each, Either, Nobody, everyone” etc. which are always followed with singular verbs.

S128. Ans.(a)

Sol. We can use either ‘should’ or ‘might’ in place of the highlighted portion as the main clause he left the Tv is in past tense and in accordance with that the clause of purpose (i.e. **so that** in this case) /clause of result will also be in the past tense.

S129. Ans.(a)

Sol. The idiom, “**cut the mustard**” means “*to be up to the standard/ to succeed*”. Among the given statements, both the sentences (I) and (II) express the meaning which complies with the meaning of the phrase and at the same time they make sure that the actual meaning of the sentence remains intact. Statement (III) is irrelevant as it alters the meaning of the actual statement. Hence (a) is the correct option.

S130. Ans.(d)

Sol. The idiom, ‘**Elvis had left the building**’ means ‘*the show is ended and go home now*’ Among the given statements, both the sentences (I) and (III) express the meaning which complies with the meaning of the phrase and at the same time they make sure that the actual meaning of the sentence remains intact. Statement (II) is irrelevant as it alters the meaning of the actual statement. Hence (d) is the correct option.

S131. Ans.(b)

Sol. The idiom, ‘**method in your madness**’ means ‘*A specific, rational purpose in what one is doing or planning, even though it may appear crazy or absurd to another person.*’ Among the given statements, only (III) expresses the meaning which complies with the meaning of the phrase and at the same time they make sure that the actual meaning of the sentence remains intact. Statements (I) and (II) are irrelevant as they alter the meaning of the actual statement. Hence (b) is the correct option.

S132. Ans.(e)

Sol. The idiom, ‘**off the record**’ means ‘*Not made as an official or attributable statement.*’ Among the given statements, all the statements express the meaning which complies with the meaning of the phrase and at the same time they make sure that the actual meaning of the sentence remains intact. Hence (e) is the correct option.

S133. Ans.(d)

Sol. For the highlighted words, the correct arrangement will be CADB. Also, “mortality” must be replaced with “mobility” to make the statement grammatically and contextually correct.

S134. Ans.(b)

Sol. Among the given set of highlighted, the correct rearrangement will be BCDA. Also, none of the highlighted words need to be replaced. Hence, option (b) is the most suitable answer choice.

S135. Ans.(d)

Sol. For the given highlighted words, the most appropriate sequence after rearrangement is DCBA. Also, to make the statement grammatically and contextually correct, “revived” will be replaced with “remains”. Hence, option (d) is the most suitable answer choice.

NRA-CET Ready

BANK

Useful for Bank & Insurance Exams

TEST PACK

12 Months Subscription

S136. Ans.(e)

Sol. For the given highlighted words, all of them are at their correct positions and do not require any interchange. Hence, option (e) is the most suitable answer choice.

S137. Ans.(c)

Sol. For the given highlighted words, the most appropriate sequence after rearrangement is **CDAB**. Also, to make the statement grammatically and contextually correct, “trending” will be replaced with “tackling”. Hence, option (c) is the most suitable answer choice.

S138. Ans.(b)

Sol. Among the given set of options, “predilection” is the synonym of “fondness” whereas “aversion” is its antonym. Hence, option (b) is the most suitable answer choice.

Predilection- a preference or special liking for something; a bias in favour of something

Callow- (of a young person) inexperienced and immature

Predicament- a difficult, unpleasant, or embarrassing situation

S139. Ans.(c)

Sol. Among the given set of options, “obstinate” is the synonym of “**stubborn**” whereas “tractable” is its antonym. Hence, option (c) is the most suitable answer choice.

Impromptu- done without being planned or rehearsed

Sluggish- slow-moving or inactive

S140. Ans.(c)

Sol. Among the given set of options, “commotion” is the synonym of “**ruckus**” whereas “tranquility” is its antonym. Hence, option (c) is the most suitable answer choice.

Furore- an outbreak of public anger or excitement

Pungent- having a sharply strong taste or smell

Scarcity- the state of being scarce or in short supply; shortage

S141. Ans.(d)

Sol. A 17-year-old girl, Khushi Chindaliya has been appointed as Regional Ambassador for India by the United Nations Environment Programme (UNEP)- Tunza Eco-Generation.

In her new role, Khushi will raise awareness about climate change and the importance of environmental conservation and the need to safeguard environmental treasures.

She will work with the TEG on various environmental awareness programmes till February 2021.

S142. Ans.(c)

Sol. Atal tunnel is the world’s longest highway tunnel above 10,000 ft. This 9.02 km long tunnel connects Manali to Lahaul & Spiti Valley throughout the year. It has been named after former Indian Prime Minister Atal Bihari Vajpayee.

This all-weather tunnel will reduce the distance between Manali & Leh by 46 kms. It is also the country’s first tunnel to have an escape tunnel within the main tunnel because of the topography.

S143. Ans.(b)

Sol. Online live tutoring company Vedantu on Monday said it has onboarded Bollywood actor Aamir Khan as its brand ambassador.

Vedantu with its new ad campaign aims to make quality LIVE online learning accessible to every child, every home with India's best curated teachers.

S144. Ans.(a)

Sol. The Indian Navy (IN) has commenced a Passage Exercise (PASSEX) with Royal Australian Navy (RAN) in the East Indian Ocean Region.

The exercise would involve participation of HMAS Hobart from the Australian side and Indian Naval Ships Sahyadri and Karmuk. PASSEXs are regularly conducted by IN with units of friendly foreign navies, whilst visiting each other's ports or during a rendezvous at sea.

S145. Ans.(d)

Sol. Multi-talented Ashleigh Barty has conquered tennis, been a professional cricketer and has now added another string to her sporting bow by winning Brookwater Golf Club women's championship.

The 24-year-old Australian, who famously played professional cricket during a year out from tennis, decided not to leave home for the U.S. Open or her title defence at Roland Garros because of the pandemic.

S146. Ans.(e)

Sol. India on 22nd September successfully conducted the flight test of ABHYAS - High-speed Expendable Aerial Target (HEAT) - from a test range in Odisha

ABHYAS has been designed and developed by the Aeronautical Development Establishment (ADE) of the DRDO. The vehicle has been programmed for fully autonomous flight. The check out of the air vehicle is done using laptop-based Ground Control Station (GCS).

S147. Ans.(c)

Sol. Ministry of Human Resource Development has been renamed as Ministry of Education. The Union Cabinet has approved the change in the name of the ministry. The HRD Ministry is currently headed by Ramesh Pokhriyal Nishank.

S148. Ans.(a)

Sol. The Ministry of Information and Broadcasting on 30th September appointed filmmaker Shekhar Kapur president of Pune's Film and Television Institute of India Society and chairperson of the institute's governing council.

He will succeed television producer-director BP Singh, best known as director of the popular TV series CID. Kapur's tenure will last till March 3, 2023.

S149. Ans.(a)

Sol. Flight Lieutenant Shivangi Singh will be the first woman pilot to fly Rafale, India's most modern multi-role fighter aircraft.

It has been known for a while that the IAF is training a woman fighter pilot to fly the Rafale, which was inducted into the force at the Ambala base earlier this month, but her name has come to light only now. She has been undergoing conversion training — the course pilots undertake when they switch from flying one aircraft to another — since August.

S150. Ans.(d)

Sol. India's business tycoon Mukesh Ambani continues to top the IIFL Wealth Hurun India Rich list 2020 for the ninth consecutive year with a total wealth of Rs 6,58,400 crore.

Hinduja Brothers, Hinduja group (Wealth: Rs 1,43,700 crore), Shiv Nadar, HCL Technologies (Wealth: Rs 1,41,700 crore) 2nd and 3rd Position Respectively.

S151. Ans.(a)

Sol. Uttar Pradesh Chief Minister Yogi Adityanath launched the “hath dhona, roke corona” campaign on October 15, 2020. This campaign was launched while emphasising upon the sanitation practices on the occasion of Global Handwashing Day.

The Chief Minister stressed that common habits of personal hygiene including washing hands can protect from coronavirus infection.

S152. Ans.(b)

Sol. The Insurance Regulatory and Development Authority of India (Irdai) has come out with a standard, individual term life insurance product called Saral Jeevan Bima. This will be mandatorily offered by all life insurance companies from January 1, 2021, onwards. Insurers have to file the product with the regulator latest by December 1.

The Saral Jeevan Bima product to be offered by all life insurance companies will be a non-linked non-participating individual pure-risk premium life insurance plan.

S153. Ans.(b)

Sol. The first Indian to win the Oscar award, Bhanu Athaiya passed away. She won the Best Costume Design Oscar for her work in the 1982 film Gandhi, directed by Richard Attenborough.

Began her career as a costume designer in Hindi cinema with Guru Dutt's 1956 superhit “C.I.D.”. She went on to work in over 100 films.

S154. Ans.(a)

Sol. India has provided 1.54 billion Nepalese Rupees (INR nearly 96 crores) to Nepal as part of its commitment towards assistance and rehabilitation after the 2015 earthquake which saw the death of over 9,000 people in the country.

The financial support was provided as housing and school sector assistance and would further help in the renovation of educational institutions and houses for the people affected in the natural disaster.



TEST SERIES
Bilingual
Video Solutions
RBI ASSISTANT
MAINS
25 Total Tests | eBooks

S155. Ans.(b)

Sol. Indian and Japanese navies to begin their three-day-long maritime military exercise beginning from September 26. The naval exercise will take place in the North Arabian Sea. This is the fourth edition of Japan Maritime bilateral exercise (JIMEX).

The exercise is taking place in the backdrop of growing concerns over China's military activity in the Indian Ocean Region as well as in the Indo-Pacific.

S156. Ans.(c)

Sol. Department for Promotion of Industry and Internal Trade (DPIIT), Ministry of Commerce and Industry signed a Memorandum of Understanding (MoU) in the field of Intellectual Property Cooperation with the Danish Patent and Trademark Office, Ministry of Industry, Business and Financial Affairs, Kingdom of Denmark.

Exchange of best practices, experiences and knowledge on IP awareness among public, authorities, businesses and research and educational institution of both countries. Collaboration in training programmes, exchange of experts, technical exchanges and outreach activities.

S157. Ans.(c)

Sol. According to the World Risk Index (WRI) 2020, India is 'poorly prepared' to deal with 'climate reality', due to which it is vulnerable to extreme natural disasters. World Risk Report 2020 released by the United Nations University Institute for Environment and Human Security (UNU-EHS), Bundnis Entwicklung Hilft and the University of Stuttgart in Germany.

Vanuatu (South Pacific Ocean) is the country with the highest disaster risk worldwide. It is followed by Tonga (South Pacific Ocean) and Dominica (Caribbean Sea). India has ranked 89th among 181 countries on the WRI 2020 and is fourth-most-at-risk in South Asia, after Bangladesh, Afghanistan and Pakistan.

S158. Ans.(d)

Sol. Valtteri Bottas has won Russian Grand Prix 2020. Valtteri Bottas won the Russian Grand Prix in Sochi as Lewis Hamilton was left frustrated after a 10-second time penalty denied him the chance to equal Michael Schumacher's record tally of 91 Formula One race wins.

S159. Ans.(e)

Sol. Odisha's newly constructed architectural marvel Krushi Bhawan has won the People's Choice Award in the 'Social Good Category' at AZ Awards 2020. The Krushi Bhawan was the only project from India at the globally acknowledged prestigious award.

Odisha's Chief Minister Naveen Patnaik tweeted and dedicated the award to the farmer and artisans of Odisha who is the influence behind the design of the Krushi Bhawan.

S160. Ans.(b)

Sol. Somalia President Mohamed Farmaajo appointed Mohamed Hussein Roble as the country's new prime minister on 22nd September.

He will replace former Prime Minister Hassan Ali Khayre, who was voted out of office by parliament in July.

S161. Ans.(c)

Sol. Colombian investigative journalist Jineth Bedoya Lima has been named as the laureate of the 2020 UNESCO/Guillermo Cano World Press Freedom Prize on the recommendation of an independent international jury of media professionals.

Jineth Bedoya Lima's reporting has focused on the armed conflict and peace process in Colombia and on sexual violence against women.

S162. Ans.(d)

Sol. The first ever Cargo Ferry Service between India and the Maldives was jointly launched on 21st September opening a new chapter in connectivity initiatives in the Indian Ocean Region.

The Cargo Ferry Vessel MCP Linz operated by the Shipping Corporation of India (SCI) will connect Tuticorin and Cochin ports in India with Kulhudhufushi and Male ports in the Maldives.

S163. Ans.(c)

Sol. Novak Djokovic has defeated Argentine Diego Schwartzman, 7-6, 5-3, to win 2020 Men's Single Italian Open title and his fifth overall Rome title.

In Women's single, Simona Halep defeated champion Karolina Pliskova, 6-0, 2-1, to win her first Italian Open title.

S164. Ans.(c)

Sol. Being the country of Mahatma Gandhi, India has a huge legacy of contributing to world peace. In a world troubled with conflict, a day dedicated to peace reminds us of Mahatma Gandhi's philosophy of Ahimsa or non-violence.

International Day of Peace is observed every year on September 21. It is a United Nations-designated day, established in 1981.

Theme 2020: "Shaping Peace Together."

S165. Ans.(b)

Sol. 72nd Emmys Awards 2020. Popular sitcom Schitt's Creek won most awards in a single season by a comedy series. He took home seven Primetime awards and nine Emmys in the comedy categories. The family saga series Succession took home five awards that also include best drama series at the 72nd Emmy Awards. Thus, a new record is set.

Euphoria's Zendaya became the youngest winner for best lead actress in the drama series category.

A mini FRIENDS reunion also took place with the show's three female leads – Jennifer Aniston, Courteney Cox and Lisa Kudrow.

S166. Ans.(c)

Sol. In a first-of-its-kind initiative, eight beaches of India have been recommended for the Blue flag certification. The selection of the beaches was made by an independent national jury composed of eminent environmentalists and scientists.

About Blue Flag certification- The Blue Flag certificate is an internationally recognized eco-label given by 'Foundation for Environment Education, Denmark'. Blue Flag beaches are considered the benchmark for clean and hygienic beaches in the world.

This announcement was made by the Union Minister of Environment, Forest and Climate Change (MoEFCC), Prakash Javadekar on 18 September during a virtual event.

List of eight beaches selected for Blue flag certification are

Shivrajpur in Gujarat

Ghoghla in Daman & Diu

Kasarkod in Karnataka

Padubidri beach in Karnataka

Kappad in Kerala

Rushikonda in Andhra Pradesh

The golden beach of Odisha

Radhanagar beach in Andaman and Nicobar

S167. Ans.(b)

Sol. Prime Minister Narendra Modi has been awarded the Ig Nobel Prize 2020 for Medical Education. Modi was awarded the prize for "using the COVID-19 pandemic to teach the world that politicians can have a more immediate effect on life and death than scientists and doctors can".

Besides Modi, the medical education prize was jointly awarded to Jair Bolsonaro of Brazil, Boris Johnson of the United Kingdom, Andrés Manuel López Obrador of Mexico, Alexander Lukashenko of Belarus, Donald Trump of the USA, Recep Tayyip Erdogan of Turkey, Vladimir Putin of Russia, and Gurbanguly Berdimuhamedow of Turkmenistan.

S168. Ans.(a)

Sol. PM Narendra Modi has launched 9 highway projects and Ghar tak Fiber scheme in Bihar on 21 September 2020. Under the Ghar tak fibre Scheme, optical fibre services will be provided to every households.

Bihar Highway projects will construct 350 kilometers of road. The roads will be built at a cost of Rs 14,250 crores (Rs 142.5 Billions). The Optical Fibre Services project is to be implemented GoI's Ministry of Electronics and Information Technology under the Ghar Tak Fibre Scheme (GTFD). It will connect 45,945 villages inter-state.

S169. Ans.(b)

Sol. Aviation giant Airbus on 21st September revealed three concepts for the world's first zero-emission commercial aircraft which could enter into service by 2035.

All of these concepts are powered by hydrogen - an option that the European firm believes holds exceptional promise as a clean aviation fuel and is likely to be a solution for aerospace and many other industries to meet their climate-neutral targets.

TEST SERIES
Bilingual
VIDEO SOLUTIONS



IBPS CLERK 2020
PRIME

125+ TESTS | eBooks

S170. Ans.(d)

Sol. A 17-year-old girl, Khushi Chindaliya has been appointed as Regional Ambassador for India by the United Nations Environment Programme (UNEP)- Tunza Eco-Generation.

In her new role, Khushi will raise awareness about climate change and the importance of environmental conservation and the need to safeguard environmental treasures.

She will work with the TEG on various environmental awareness programmes till February 2021.

S171. Ans.(c)

Sol. Debit card an electronic card of a customer's personal account that gives the ability to make card payments or withdraw cash from an ATM.

S172. Ans.(d)

Sol. The Banking Ombudsman may award compensation not exceeding ₹ 1 lakh (₹ One Hundred Thousand) to the complainant for mental agony and harassment

S173. Ans.(a)

Sol. The Ministry of Statistics and Programme Implementation measures inflation in India.

S174. Ans.(b)

Sol. Qualitative controls are designed to regulate the Direction of credit.

S175. Ans.(d)

Sol. Full form of UPI is Unified Payment Interface.

S176. Ans.(c)

Sol. Base year to calculate CPI in India is 2012.

S177. Ans.(d)

Sol. Banking Ombudsman scheme does Not cover NABARD under it.

S178. Ans.(d)

Sol. The 16-digit number (often grouped into four's) found on the front of your debit card is known as the Card number.

S179. Ans.(d)

Sol. SBI started a programme by the name "Mahila Atmanirbharshil Aachani" (Women Self-Reliance programme) support Atmanirbhar Bharat Abhijan launched by Prime Minister of India to the ground level.

SBI stated that women SHGs are very active and credit worthy in rural areas of Assam as it relies on social collateral rather than on financial collateral. It also empowers the women by encouraging them to create their micro enterprises for self-reliance and to maintain a sustainable economic condition.

S180. Ans.(b)

Sol. The Reserve Bank of India (RBI) will implement the “Technology Vision for Cyber Security’ for Urban Co-operative Banks (2020-2023) to enhance the IT security system of Urban Co-operative banking to prevent, detect, respond to and recover from cyber-attacks.

The Technology Vision Document aims at enhancing the cybersecurity posture of the Urban Co-operative banking sector against evolving IT and cyber threat environment. RBI will achieve this objective using its five-pillared strategic approach ‘GUARD’.

S181. Ans.(a)

Sol. Overshadowed by the peak of Nanda Devi, the Nanda Devi National Park is located amidst the upper Himalayan ranges of the Chamoli district of Uttarakhand. The Nanda Devi National Park has one of the world's richest floral species, comprising of 312 species with around 17 rarest one.

S182. Ans.(b)

Sol. The 2980MW Sipat Super Thermal Power Plant located at Sipat in the Bilaspur district of Chhattisgarh, ranks as the fifth largest thermal power station in India. It is a coal-based power plant owned and operated by NTPC.

S183. Ans.(d)

Sol. Supa Dam is built across Kalinadi (Kannada) or Kali river in state of Karnataka in India.

S184. Ans.(b)

Sol. Illiberal India is written by Chidanand Rajghatta, the former husband of the slain Gauri Lankesh.

S185. Ans.(b)

Sol. State Bank of India set up its payment gateway - SBI ePay — with the objective of enrolling government entities and municipal corporations as well as small traders in the online marketplace.

S186. Ans.(c)

Sol. BNP Paribas is an international banking group with a presence in 75 countries. It was formed through the merger of Banque Nationale de Paris (BNP) (established in 1848) and Paribas (established in 1872) in 2000. BNP Paribas has the highest brand value in France

S187. Ans.(b)

Sol. Samit Ghosh is the Managing Director & CEO of Ujjivan Small Finance Bank Ltd. Its Headquarters in Bengaluru, Karnataka.

S188. Ans.(b)

Sol. Headquarters: New Delhi

S189. Ans.(d)

Sol. Capital: Mogadishu

Currencies: United States Dollar, Somali shilling

S190. Ans.(b)

Sol. Former defence minister Jaswant Singh passed away on 27th Septmeber. He was 82. In 2014, he was admitted to the Army (Research and Referral) Hospital in Delhi following a severe head injury at his residence.

Singh had contested the 2014 Lok Sabha elections as an Independent candidate from Barmer district in Rajasthan after he did not get a BJP ticket.

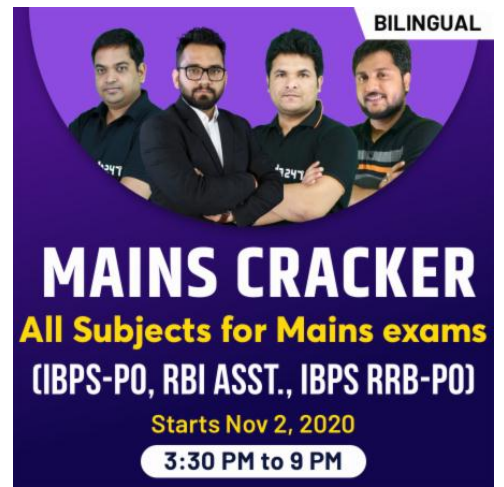

BILINGUAL

MAINS CRACKER

All Subjects for Mains exams

(IBPS-PO, RBI ASST., IBPS RRB-PO)

Starts Nov 2, 2020

3:30 PM to 9 PM



BOOKS



Visit: publications.adda247.com & store.adda247.com
 For any information, mail us at publications@adda247.com