

HPCL Engineer

**Previous Year Paper
(Electrical)
23 Dec, 2023**

Adda247

Test Prime

ALL EXAMS, ONE SUBSCRIPTION



80,000+
Mock Tests



**Personalised
Report Card**



**Unlimited
Re-Attempt**



600+
Exam Covered



20,000+ Previous
Year Papers



500%
Refund



ATTEMPT FREE MOCK NOW



HINDUSTAN PETROLEUM CORPORATION LIMITED
REGISTERED OFFICE : 17, JAMSHEDJI TATA ROAD, MUMBAI - 400 020.

| | |
|------------------|---------------------|
| Participant ID | |
| Participant Name | |
| Test Center Name | |
| Test Date | 23/12/2023 |
| Test Time | 2:00 PM - 4:30 PM |
| Subject | Electrical Engineer |

Section : English Language

Q.1 Choose the most logical order of the sentences from among the four given choices to construct a coherent paragraph.

Language is a tool used by society to communicate since ancient times.

A) Therefore, schools such as the Full Boarding School, for example, provide an opportunity for students to learn five international languages, namely, French, German, Japanese, Chinese, and Arabic through international language learning.

B) Therefore, many benefits will be obtained by someone who masters other languages besides the mother tongue.

C) In facing this globalization era, the ability to master and communicate in various languages is an advantage to an individual.

D) Without the ability and proficiency in speaking in various languages, it is quite difficult for someone to communicate especially with individuals of different races.

- Ans
1. ABCD
 2. CADB
 3. DACB
 4. CBDA

Question ID : 630680507281

Option 1 ID : 6306801982579

Option 2 ID : 6306801982578

Option 3 ID : 6306801982577

Option 4 ID : 6306801982580

Status : Answered

Chosen Option : 2

Q.2 Select the most appropriate SYNONYM of the given word below.

Precedence

- Ans
1. Priority
 2. Unnecessary
 3. Unwanted
 4. Secondary

Question ID : 630680507287

Option 1 ID : 6306801982601

Option 2 ID : 6306801982603

Option 3 ID : 6306801982604

Option 4 ID : 6306801982602

Status : Answered

Chosen Option : 4

Q.3 Choose the most appropriate one-word substitution for the below word.

"The study of the evolution of mankind"

- Ans
1. Botany
 2. Geology
 3. Anthropology
 4. Lexicography

Question ID : 630680507282
Option 1 ID : 6306801982584
Option 2 ID : 6306801982582
Option 3 ID : 6306801982583
Option 4 ID : 6306801982581
Status : Answered
Chosen Option : 3

Q.4 Fill in the blank with the correct word from the below options.

Spending three days working on a farm in rural China has given me a newfound _____ for the difficulties of farming and the challenges faced by farmers.

- Ans
1. appreciation
 2. pleasure
 3. contempt
 4. disgust

Question ID : 630680507288
Option 1 ID : 6306801982606
Option 2 ID : 6306801982608
Option 3 ID : 6306801982607
Option 4 ID : 6306801982605
Status : Answered
Chosen Option : 1

Q.5 In the following question a part of the statement is given in brackets. You are required to replace the text with correct Idioms given in the options.

David thought Christopher was the one who broke the vase, but he was (looking for the answers in the wrong place).

- Ans
1. barking up the wrong tree
 2. pleased as punch
 3. on the ball
 4. miss the boat

Question ID : 630680507284
Option 1 ID : 6306801982591
Option 2 ID : 6306801982592
Option 3 ID : 6306801982590
Option 4 ID : 6306801982589
Status : Answered
Chosen Option : 1

Q.6 Fill in the blank with the correct word from the below options.

Spending three days working on a farm in rural China has given me a newfound adoration for the difficulties of farming and the challenges faced by farmers. I now understand the difficulties _____ in digging up potatoes and carrying them back home and appreciate the hard work that goes into providing for a family.

- Ans
1. attracted
 2. unimaginable
 3. evolved
 4. involved

Question ID : 630680507290
Option 1 ID : 6306801982614
Option 2 ID : 6306801982616
Option 3 ID : 6306801982615
Option 4 ID : 6306801982613
Status : Answered
Chosen Option : 4

Q.7 Select the most appropriate adjective from the given option to fill in the blanks for the given sentence.

We were _____ when we heard the news.

- Ans
1. bored
 2. shocking
 3. shocked
 4. amazing

Question ID : 630680507279
Option 1 ID : 6306801982572
Option 2 ID : 6306801982570
Option 3 ID : 6306801982571
Option 4 ID : 6306801982569
Status : Answered
Chosen Option : 3

Q.8 In the following question a part of the statement is given in brackets. You are required to replace the text with correct Idioms given in the options.

We're (trying very hard but have little or no success) here; we need a plan before we do any more work.

- Ans
1. spill the beans
 2. sleep like a log
 3. selling like hotcakes
 4. just running in circles

Question ID : 630680507285
Option 1 ID : 6306801982596
Option 2 ID : 6306801982595
Option 3 ID : 6306801982593
Option 4 ID : 6306801982594
Status : Answered
Chosen Option : 4

Q.9 Choose the most appropriate one-word substitution for the below word.

"A large cage, building, or enclosure to keep birds "

- Ans
1. Asylum
 2. Aviary
 3. Casino
 4. Apiary

Question ID : 630680507283
Option 1 ID : 6306801982587
Option 2 ID : 6306801982586
Option 3 ID : 6306801982588
Option 4 ID : 6306801982585
Status : Answered
Chosen Option : 2

Q.10 Fill in the blank with the correct word from the below options.

Spending three days working on a farm in rural China has given me a newfound respect for the difficulties of farming and the challenges faced by farmers. Prior to this experience, I had never considered the amount of _____ required to produce the potatoes we eat at home.

- Ans
1. effort
 2. force
 3. ease
 4. inactivity

Question ID : 630680507289
Option 1 ID : 6306801982609
Option 2 ID : 6306801982611
Option 3 ID : 6306801982610
Option 4 ID : 6306801982612
Status : Answered
Chosen Option : 1

Q.11 Choose the most logical order of the sentences from among the four given choices to construct a coherent paragraph.

In this era of globalization, society seems to be too busy chasing worldly luxuries and often neglects healthy lifestyle practices, especially recreational activities.

- A) This is because they take the importance of recreational activities lightly.
B) Without realizing it, there are actually various benefits of recreation to society.
C) One of the benefits of recreation to society is the ability to strengthen relationships, whether with the local community or with one's own family members. This is because through recreational activities, individuals will interact with others around them, thus strengthening relationships.
D) For example, through recreational activities, we can have friendly conversations with neighbors. It is clear that recreation can strengthen relationships between individuals.

- Ans
1. ABCD
 2. ACBD
 3. ADBC
 4. BDAC

Question ID : 630680507280
Option 1 ID : 6306801982576
Option 2 ID : 6306801982575
Option 3 ID : 6306801982574
Option 4 ID : 6306801982573
Status : Answered
Chosen Option : 1

Q.12 Select the most appropriate SYNONYM of the given word below.

Discern

- Ans
1. Notice
 2. Ignore
 3. Neglect
 4. Disregard

Question ID : 630680507286
Option 1 ID : 6306801982598
Option 2 ID : 6306801982597
Option 3 ID : 6306801982600
Option 4 ID : 6306801982599
Status : Answered
Chosen Option : 2

Q.13 Select the most appropriate adjective from the given option to fill in the blanks for the given sentence.

The movie we watched last night was _____.

- Ans
1. terrified
 2. Boring
 3. interested
 4. bored

Question ID : 630680507278
Option 1 ID : 6306801982565
Option 2 ID : 6306801982568
Option 3 ID : 6306801982567
Option 4 ID : 6306801982566
Status : Answered
Chosen Option : 2

Comprehension:

Read the below passage and answer the questions.

Tobacco is a deadly menace, responsible for millions of deaths annually. It is highly addictive and contains harmful substances that can lead to a variety of diseases, including cancer, heart disease, and stroke. The tobacco industry invests heavily in advertising to perpetuate addiction and counter efforts towards cessation.

To combat smoking, we need to prioritize the well-being of our youth and equip them with the necessary knowledge and support to resist the allure of smoking. We also need to raise awareness among the broader community about the devastating consequences of tobacco use. Efforts to combat smoking must extend beyond individual actions and include robust policies and regulations. Strict laws limiting tobacco advertising, particularly targeting vulnerable populations like young people, should be enforced. Implementing smoke-free policies in public spaces, workplaces, and public transportation can protect non-smokers from the harmful effects of secondhand smoke.

Creating a united front against tobacco requires collaboration between government bodies, healthcare organizations, non-profit groups, and individuals. By pooling resources and expertise, impactful strategies can be implemented to reduce smoking rates and prevent unnecessary deaths.

In the pursuit of a tobacco-free future, ongoing research and development play a vital role. Scientists and medical professionals should continue investigating the long-term effects of smoking and developing innovative cessation methods. Accessible and affordable treatments, including counselling services, nicotine replacement therapies, and medications, must be made available to those seeking to quit smoking.

The journey towards a tobacco-free society demands perseverance, determination, and a collective effort. Public health must take precedence over the interests of the tobacco industry. By empowering individuals, implementing strong policies, and fostering a culture of health, we can pave the way for a brighter, smoke-free future for generations to come.

SubQuestion No : 14

Q.14 Identify the central theme of the passage.

- Ans**
1. The passage talks about the importance of tobaccos to tackle boredom.
 2. The passage talks about the different methods to quit or reduce smoking.
 3. The passage talks about the pooling of resources and expertise to be implemented to enhance smoking rates and prevent unnecessary deaths.
 4. The passage talks about the collective efforts required by individuals and the concerned authorities to ensure a smoke-free future for generations.

Question ID : 630680507293

Option 1 ID : 6306801982622

Option 2 ID : 6306801982623

Option 3 ID : 6306801982621

Option 4 ID : 6306801982624

Status : Answered

Chosen Option : 4

Comprehension:

Read the below passage and answer the questions.

Tobacco is a deadly menace, responsible for millions of deaths annually. It is highly addictive and contains harmful substances that can lead to a variety of diseases, including cancer, heart disease, and stroke. The tobacco industry invests heavily in advertising to perpetuate addiction and counter efforts towards cessation.

To combat smoking, we need to prioritize the well-being of our youth and equip them with the necessary knowledge and support to resist the allure of smoking. We also need to raise awareness among the broader community about the devastating consequences of tobacco use. Efforts to combat smoking must extend beyond individual actions and include robust policies and regulations. Strict laws limiting tobacco advertising, particularly targeting vulnerable populations like young people, should be enforced. Implementing smoke-free policies in public spaces, workplaces, and public transportation can protect non-smokers from the harmful effects of secondhand smoke.

Creating a united front against tobacco requires collaboration between government bodies, healthcare organizations, non-profit groups, and individuals. By pooling resources and expertise, impactful strategies can be implemented to reduce smoking rates and prevent unnecessary deaths.

In the pursuit of a tobacco-free future, ongoing research and development play a vital role. Scientists and medical professionals should continue investigating the long-term effects of smoking and developing innovative cessation methods. Accessible and affordable treatments, including counselling services, nicotine replacement therapies, and medications, must be made available to those seeking to quit smoking.

The journey towards a tobacco-free society demands perseverance, determination, and a collective effort. Public health must take precedence over the interests of the tobacco industry. By empowering individuals, implementing strong policies, and fostering a culture of health, we can pave the way for a brighter, smoke-free future for generations to come.

SubQuestion No : 15

Q.15 Select the most appropriate **SYNONYM** of the given word below.

Cessation

- Ans**
1. Extension
 2. Survival
 3. Ending
 4. Continuation

Question ID : 630680507295

Option 1 ID : 6306801982630

Option 2 ID : 6306801982631

Option 3 ID : 6306801982632

Option 4 ID : 6306801982629

Status : Answered

Chosen Option : 3

Comprehension:

Read the below passage and answer the questions.

Tobacco is a deadly menace, responsible for millions of deaths annually. It is highly addictive and contains harmful substances that can lead to a variety of diseases, including cancer, heart disease, and stroke. The tobacco industry invests heavily in advertising to perpetuate addiction and counter efforts towards cessation.

To combat smoking, we need to prioritize the well-being of our youth and equip them with the necessary knowledge and support to resist the allure of smoking. We also need to raise awareness among the broader community about the devastating consequences of tobacco use. Efforts to combat smoking must extend beyond individual actions and include robust policies and regulations. Strict laws limiting tobacco advertising, particularly targeting vulnerable populations like young people, should be enforced. Implementing smoke-free policies in public spaces, workplaces, and public transportation can protect non-smokers from the harmful effects of secondhand smoke.

Creating a united front against tobacco requires collaboration between government bodies, healthcare organizations, non-profit groups, and individuals. By pooling resources and expertise, impactful strategies can be implemented to reduce smoking rates and prevent unnecessary deaths.

In the pursuit of a tobacco-free future, ongoing research and development play a vital role. Scientists and medical professionals should continue investigating the long-term effects of smoking and developing innovative cessation methods. Accessible and affordable treatments, including counselling services, nicotine replacement therapies, and medications, must be made available to those seeking to quit smoking.

The journey towards a tobacco-free society demands perseverance, determination, and a collective effort. Public health must take precedence over the interests of the tobacco industry. By empowering individuals, implementing strong policies, and fostering a culture of health, we can pave the way for a brighter, smoke-free future for generations to come.

SubQuestion No : 16

Q.16 Identify the suitable title for the passage.

- Ans**
1. Tobacco- A public Health crisis
 2. Threats to society
 3. Efforts to combat smoking
 4. Smoke free society

Question ID : 630680507292

Option 1 ID : 6306801982617

Option 2 ID : 6306801982620

Option 3 ID : 6306801982619

Option 4 ID : 6306801982618

Status : Answered

Chosen Option : 4

Comprehension:

Read the below passage and answer the questions.

Tobacco is a deadly menace, responsible for millions of deaths annually. It is highly addictive and contains harmful substances that can lead to a variety of diseases, including cancer, heart disease, and stroke. The tobacco industry invests heavily in advertising to perpetuate addiction and counter efforts towards cessation.

To combat smoking, we need to prioritize the well-being of our youth and equip them with the necessary knowledge and support to resist the allure of smoking. We also need to raise awareness among the broader community about the devastating consequences of tobacco use. Efforts to combat smoking must extend beyond individual actions and include robust policies and regulations. Strict laws limiting tobacco advertising, particularly targeting vulnerable populations like young people, should be enforced. Implementing smoke-free policies in public spaces, workplaces, and public transportation can protect non-smokers from the harmful effects of secondhand smoke.

Creating a united front against tobacco requires collaboration between government bodies, healthcare organizations, non-profit groups, and individuals. By pooling resources and expertise, impactful strategies can be implemented to reduce smoking rates and prevent unnecessary deaths.

In the pursuit of a tobacco-free future, ongoing research and development play a vital role. Scientists and medical professionals should continue investigating the long-term effects of smoking and developing innovative cessation methods. Accessible and affordable treatments, including counselling services, nicotine replacement therapies, and medications, must be made available to those seeking to quit smoking.

The journey towards a tobacco-free society demands perseverance, determination, and a collective effort. Public health must take precedence over the interests of the tobacco industry. By empowering individuals, implementing strong policies, and fostering a culture of health, we can pave the way for a brighter, smoke-free future for generations to come.

SubQuestion No : 17

Q.17 Select the most appropriate **SYNONYM** of the given word below.

Combat

- Ans**
1. Encourage
 2. Promote
 3. Oppose
 4. Forward

Question ID : 630680507294

Option 1 ID : 6306801982626

Option 2 ID : 6306801982628

Option 3 ID : 6306801982627

Option 4 ID : 6306801982625

Status : Answered

Chosen Option : 3

Section : Quantitative Aptitude**Q.1**

- Ans**
- 1.
 - 2.
 - 3.
 - 4.

Question ID : 630680507654

Option 1 ID : 6306801984059

Option 2 ID : 6306801984057

Option 3 ID : 6306801984060

Option 4 ID : 6306801984058

Status : Answered

Chosen Option : 1

Q.2

- Ans
- 1.
 - 2.
 - 3.
 - 4.

Question ID : 630680507669
Option 1 ID : 6306801984117
Option 2 ID : 6306801984120
Option 3 ID : 6306801984118
Option 4 ID : 6306801984119
Status : Answered
Chosen Option : 4

Q.3

- Ans
- 1.
 - 2.
 - 3.
 - 4.

Question ID : 630680507667
Option 1 ID : 6306801984111
Option 2 ID : 6306801984112
Option 3 ID : 6306801984110
Option 4 ID : 6306801984109
Status : Answered
Chosen Option : 1

Q.4

- Ans
- 1.
 - 2.
 - 3.
 - 4.

Question ID : 630680507641
Option 1 ID : 6306801984005
Option 2 ID : 6306801984008
Option 3 ID : 6306801984006
Option 4 ID : 6306801984007
Status : Answered
Chosen Option : 2

Q.5

- Ans** 1.
 2.
 3.
 4.

Question ID : **630680507645**
Option 1 ID : **6306801984024**
Option 2 ID : **6306801984021**
Option 3 ID : **6306801984022**
Option 4 ID : **6306801984023**
Status : **Answered**
Chosen Option : **1**

Q.6

- Ans** 1.
 2.
 3.
 4.

Question ID : **630680507650**
Option 1 ID : **6306801984044**
Option 2 ID : **6306801984043**
Option 3 ID : **6306801984042**
Option 4 ID : **6306801984041**
Status : **Answered**
Chosen Option : **4**

Q.7

- Ans** 1.
 2.
 3.
 4.

Question ID : **630680507657**
Option 1 ID : **6306801984070**
Option 2 ID : **6306801984071**
Option 3 ID : **6306801984069**
Option 4 ID : **6306801984072**
Status : **Answered**
Chosen Option : **1**

Q.8

Ans

- 1.
- 2.
- 3.
- 4.

Question ID : 630680507661
Option 1 ID : 6306801984088
Option 2 ID : 6306801984086
Option 3 ID : 6306801984087
Option 4 ID : 6306801984085
Status : Answered
Chosen Option : 3

Q.9

Ans

- 1.
- 2.
- 3.
- 4.

Question ID : 630680507652
Option 1 ID : 6306801984050
Option 2 ID : 6306801984052
Option 3 ID : 6306801984051
Option 4 ID : 6306801984049
Status : Answered
Chosen Option : 4

Q.10

Ans

- 1.
- 2.
- 3.
- 4.

Question ID : 630680507664
Option 1 ID : 6306801984097
Option 2 ID : 6306801984098
Option 3 ID : 6306801984099
Option 4 ID : 6306801984100
Status : Answered
Chosen Option : 4

Q.11

- Ans
- 1.
 - 2.
 - 3.
 - 4.

Question ID : 630680507653
Option 1 ID : 6306801984053
Option 2 ID : 6306801984056
Option 3 ID : 6306801984054
Option 4 ID : 6306801984055
Status : Answered
Chosen Option : 1

Q.12

- Ans
- 1.
 - 2.
 - 3.
 - 4.

Question ID : 630680507656
Option 1 ID : 6306801984067
Option 2 ID : 6306801984068
Option 3 ID : 6306801984065
Option 4 ID : 6306801984066
Status : Answered
Chosen Option : 2

Q.13

- Ans
- 1.
 - 2.
 - 3.
 - 4.

Question ID : 630680507651
Option 1 ID : 6306801984048
Option 2 ID : 6306801984046
Option 3 ID : 6306801984047
Option 4 ID : 6306801984045
Status : Answered
Chosen Option : 2

Q.14

- Ans**
- 1.
 - 2.
 - 3.
 - 4.

Question ID : **630680507655**
Option 1 ID : **6306801984061**
Option 2 ID : **6306801984062**
Option 3 ID : **6306801984064**
Option 4 ID : **6306801984063**
Status : **Answered**
Chosen Option : **2**

Q.15

- Ans**
- 1.
 - 2.
 - 3.
 - 4.

Question ID : **630680507640**
Option 1 ID : **6306801984002**
Option 2 ID : **6306801984004**
Option 3 ID : **6306801984001**
Option 4 ID : **6306801984003**
Status : **Answered**
Chosen Option : **4**

Q.16

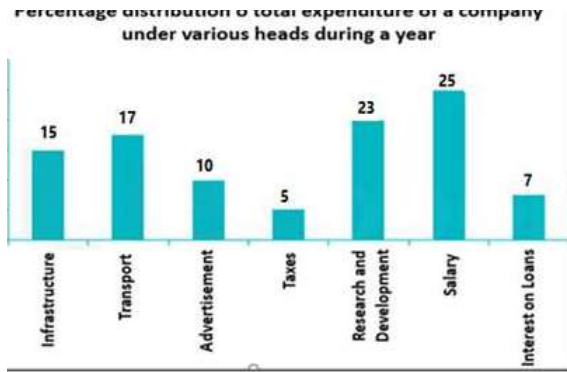

Percentage of total expenditure is spent on transportation and infrastructure?

- Ans
- 1.
 - 2.
 - 3.
 - 4.

Question ID : 630680507644
 Option 1 ID : 6306801984019
 Option 2 ID : 6306801984020
 Option 3 ID : 6306801984017
 Option 4 ID : 6306801984018
 Status : Answered
 Chosen Option : 1

Q.17

- Ans
- 1.
 - 2.
 - 3.
 - 4.

Question ID : 630680507668
 Option 1 ID : 6306801984116
 Option 2 ID : 6306801984115
 Option 3 ID : 6306801984114
 Option 4 ID : 6306801984113
 Status : Answered
 Chosen Option : 2

Q.18

- Ans
- 1.
 - 2.
 - 3.
 - 4.

Question ID : 630680507638
Option 1 ID : 6306801983994
Option 2 ID : 6306801983993
Option 3 ID : 6306801983995
Option 4 ID : 6306801983996
Status : Answered
Chosen Option : 3

Q.19

- Ans
- 1.
 - 2.
 - 3.
 - 4.

Question ID : 630680507665
Option 1 ID : 6306801984101
Option 2 ID : 6306801984103
Option 3 ID : 6306801984102
Option 4 ID : 6306801984104
Status : Answered
Chosen Option : 3

Q.20

- Ans
- 1.
 - 2.
 - 3.
 - 4.

Question ID : 630680507646
Option 1 ID : 6306801984027
Option 2 ID : 6306801984025
Option 3 ID : 6306801984028
Option 4 ID : 6306801984026
Status : Answered
Chosen Option : 2

Q.21

Ans 1.
2.
3.
4.

Question ID : 630680507666
Option 1 ID : 6306801984107
Option 2 ID : 6306801984108
Option 3 ID : 6306801984106
Option 4 ID : 6306801984105
Status : Answered
Chosen Option : 3

Q.22

Ans 1.
2.
3.
4.

Question ID : 630680507648
Option 1 ID : 6306801984036
Option 2 ID : 6306801984033
Option 3 ID : 6306801984035
Option 4 ID : 6306801984034
Status : Not Answered
Chosen Option : --

Q.23

Ans 1.
2.
3.
4.

Question ID : 630680507647
Option 1 ID : 6306801984032
Option 2 ID : 6306801984029
Option 3 ID : 6306801984030
Option 4 ID : 6306801984031
Status : Answered
Chosen Option : 1

Q.24

Ans 1.
2.
3.
4.

Question ID : 630680507671
Option 1 ID : 6306801984125
Option 2 ID : 6306801984126
Option 3 ID : 6306801984127
Option 4 ID : 6306801984128
Status : Answered
Chosen Option : 4

Q.25

Ans 1.
2.
3.
4.

Question ID : 630680507639
Option 1 ID : 6306801983997
Option 2 ID : 6306801983998
Option 3 ID : 6306801984000
Option 4 ID : 6306801983999
Status : Answered
Chosen Option : 1

Q.26

Ans 1.
2.
3.
4.

Question ID : 630680507649
Option 1 ID : 6306801984038
Option 2 ID : 6306801984040
Option 3 ID : 6306801984037
Option 4 ID : 6306801984039
Status : Not Answered
Chosen Option : --

Q.27

Ans

- 1.
- 2.
- 3.
- 4.

Question ID : 630680507670
Option 1 ID : 6306801984123
Option 2 ID : 6306801984124
Option 3 ID : 6306801984121
Option 4 ID : 6306801984122
Status : Answered
Chosen Option : 4

Q.28

Ans

- 1.
- 2.
- 3.
- 4.

Question ID : 630680507658
Option 1 ID : 6306801984074
Option 2 ID : 6306801984076
Option 3 ID : 6306801984075
Option 4 ID : 6306801984073
Status : Answered
Chosen Option : 1

Q.29

Ans

- 1.
- 2.
- 3.
- 4.

Question ID : 630680507662
Option 1 ID : 6306801984090
Option 2 ID : 6306801984092
Option 3 ID : 6306801984091
Option 4 ID : 6306801984089
Status : Answered
Chosen Option : 3

Q.30

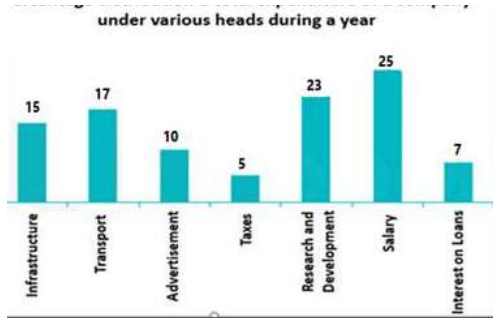

Expenditure of Salary is by what percentage more than the expenditure on transport?

- Ans
- 1.
 - 2.
 - 3.
 - 4.

Question ID : 630680507643
 Option 1 ID : 6306801984016
 Option 2 ID : 6306801984014
 Option 3 ID : 6306801984015
 Option 4 ID : 6306801984013
 Status : Answered
 Chosen Option : 4

Q.31

- Ans
- 1.
 - 2.
 - 3.
 - 4.

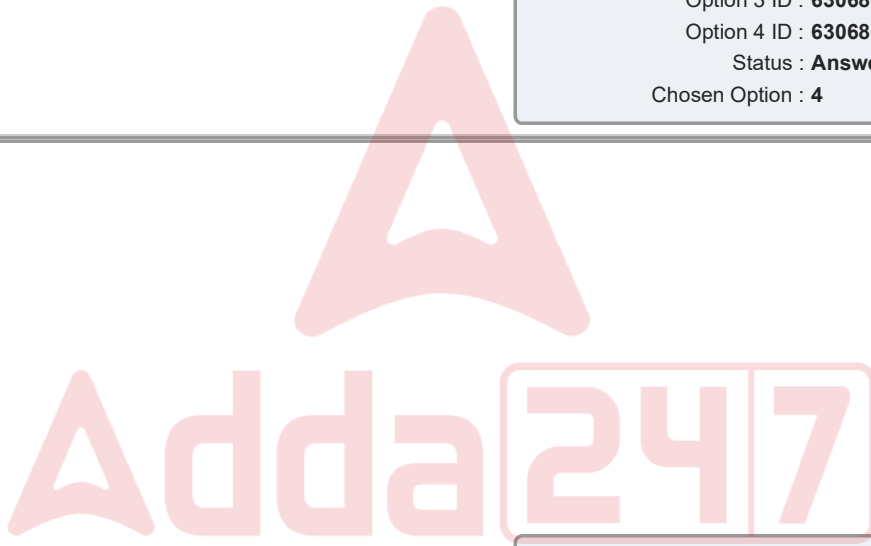

Question ID : 630680507663
 Option 1 ID : 6306801984096
 Option 2 ID : 6306801984094
 Option 3 ID : 6306801984095
 Option 4 ID : 6306801984093
 Status : Answered
 Chosen Option : 4

Q.32

- Ans
- 1.
 - 2.
 - 3.
 - 4.

Question ID : 630680507660
Option 1 ID : 6306801984081
Option 2 ID : 6306801984084
Option 3 ID : 6306801984083
Option 4 ID : 6306801984082
Status : Answered
Chosen Option : 1

Q.33

- Ans
- 1.
 - 2.
 - 3.
 - 4.

Question ID : 630680507659
Option 1 ID : 6306801984077
Option 2 ID : 6306801984079
Option 3 ID : 6306801984080
Option 4 ID : 6306801984078
Status : Answered
Chosen Option : 1

Q.34

- Ans
- 1.
 - 2.
 - 3.
 - 4.

Question ID : 630680507642
Option 1 ID : 6306801984012
Option 2 ID : 6306801984010
Option 3 ID : 6306801984009
Option 4 ID : 6306801984011
Status : Answered
Chosen Option : 3

Q.1 Which of the following option will replace the question mark?

$$73 : 16 :: 95 : ?$$

- Ans
1. 36
 2. 9
 3. 25
 4. 16

Question ID : 630680507467
Option 1 ID : 6306801983312
Option 2 ID : 6306801983311
Option 3 ID : 6306801983310
Option 4 ID : 6306801983309
Status : Not Answered
Chosen Option : --

Q.2 Which among the following option is correct on the basis of statement and courses of action?

Statement: About 50% of the students in a state high school board examination have failed due to the question paper being set that is very difficult.

Courses of Action:

- I. All the failed students are given a good lesson as they have not done hard work.
- II. Tough papers should always be set in board exams.

- Ans
1. Only I follows
 2. Both I and II follow
 3. Only II follows
 4. Neither I nor II follows

Question ID : 630680507459
Option 1 ID : 6306801983277
Option 2 ID : 6306801983279
Option 3 ID : 6306801983278
Option 4 ID : 6306801983280
Status : Answered
Chosen Option : 4

Q.3 If 'A' means 'multiplied by', 'B' means 'divided by', 'C' means 'minus' and 'D' means "plus", then what will be the value of following expression?

$$10 A 5 C 24 B 4 D 1 = ?$$

- Ans
1. 43
 2. 42
 3. 44
 4. 45

Question ID : 630680507462
Option 1 ID : 6306801983290
Option 2 ID : 6306801983289
Option 3 ID : 6306801983291
Option 4 ID : 6306801983292
Status : Answered
Chosen Option : 4

Q.4 In a certain code language, WATER is written as RETAW and SALT is written as TLAS.
How HYDROGEN will be written in the same code?

- Ans
1. HYDROGEN
 2. HYDRONEG
 3. NEGOHYDR
 4. NEGORDYH

Question ID : 630680507440
 Option 1 ID : 6306801983204
 Option 2 ID : 6306801983202
 Option 3 ID : 6306801983203
 Option 4 ID : 6306801983201
 Status : Answered
 Chosen Option : 4

Q.5 If all symbols are removed from the series what will be the 7th element from the right?

K 8 N # 5 B \$ H 6 K @ D ^ 6 L # @ 3 L M & 5

- Ans
1. 5
 2. K
 3. D
 4. 6

Question ID : 630680507447
 Option 1 ID : 6306801983230
 Option 2 ID : 6306801983229
 Option 3 ID : 6306801983232
 Option 4 ID : 6306801983231
 Status : Answered
 Chosen Option : 3

Q.6 Read the given statement(s) and conclusions carefully. Assuming that the information given in the statements is true, even if it appears to be at variance with commonly known facts, decide which of the given conclusions logically follow(s) from the statement(s).

Statements:
 Some quotes are alphabets.
 Some alphabets are words.
 All the words are poems.

Conclusions:
 I. Some words are alphabets.
 II. Some poems are quotes.
 III. All the quotes are poems.
 IV. Some poems are alphabets.

- Ans
1. Only II and III
 2. Only I and II
 3. Only III and IV
 4. Only I and IV

Question ID : 630680507443
 Option 1 ID : 6306801983214
 Option 2 ID : 6306801983213
 Option 3 ID : 6306801983215
 Option 4 ID : 6306801983216
 Status : Answered
 Chosen Option : 4

Q.7 Which of the following pair is similar to the expression below?

32587 : 78523

- Ans
1. 12345 : 12354
 2. 34817 : 71384
 3. 45823 : 32854
 4. 56732 : 23756

Question ID : 630680507465
Option 1 ID : 6306801983301
Option 2 ID : 6306801983304
Option 3 ID : 6306801983302
Option 4 ID : 6306801983303
Status : Answered
Chosen Option : 3

Q.8 Find the caretaker Prime Minister of India out of the following listed Prime Ministers?

- Ans
1. Jawahar Lal Nehru
 2. Narendra Modi
 3. Atal Bihari Vajpayee
 4. Gulzari Lal Nanda

Question ID : 630680507455
Option 1 ID : 6306801983262
Option 2 ID : 6306801983261
Option 3 ID : 6306801983264
Option 4 ID : 6306801983263
Status : Answered
Chosen Option : 4

Q.9 On the basis of classical dance and folk dance, which of the following options is different from the other three options?

- Ans
1. Bihu
 2. Mohiniattam
 3. Kathakali
 4. Bharatnatyam

Question ID : 630680507454
Option 1 ID : 6306801983260
Option 2 ID : 6306801983259
Option 3 ID : 6306801983258
Option 4 ID : 6306801983257
Status : Answered
Chosen Option : 2

Q.10 Which of the following options will replace the question marks based on the cities and their respective countries?

New York : USA :: Saint Petersburg : ?

- Ans
1. Romania
 2. Russia
 3. France
 4. Italy

Question ID : 630680507452
Option 1 ID : 6306801983252
Option 2 ID : 6306801983251
Option 3 ID : 6306801983249
Option 4 ID : 6306801983250
Status : Answered
Chosen Option : 4

Q.11 If the rank of a girl in a group is 9th from the top and 18th from the bottom, then how many more girls are required to make the total number of girls in that group 45?

- Ans
1. 16
 2. 17
 3. 18
 4. 19

Question ID : 630680507437
Option 1 ID : 6306801983189
Option 2 ID : 6306801983190
Option 3 ID : 6306801983191
Option 4 ID : 6306801983192
Status : Answered
Chosen Option : 4

Q.12 Which of the following option will replace the question mark?

56 : 121 :: 50 : ?

- Ans
1. 36
 2. 49
 3. 25
 4. 81

Question ID : 630680507466
Option 1 ID : 6306801983306
Option 2 ID : 6306801983307
Option 3 ID : 6306801983305
Option 4 ID : 6306801983308
Status : Not Answered
Chosen Option : --

Q.13 One evening just before sunset two boys Sanjiv and Manish were talking to each other face to face. If Manish's shadow was exactly to his left side, which direction was Sanjiv facing?

- Ans
1. East
 2. North
 3. South
 4. West

Question ID : 630680507444
Option 1 ID : 6306801983217
Option 2 ID : 6306801983219
Option 3 ID : 6306801983220
Option 4 ID : 6306801983218
Status : Answered
Chosen Option : 2

Q.14 What will come in place of the question marks (?) to make the series given below logically complete?

7, 24, 32, 49, 57, 74, ?

- Ans
1. 82
 2. 91
 3. 99
 4. 98

Question ID : 630680507463
Option 1 ID : 6306801983293
Option 2 ID : 6306801983295
Option 3 ID : 6306801983294
Option 4 ID : 6306801983296
Status : Answered
Chosen Option : 1

Q.15 If 'A' means 'multiplied by', 'B' means 'divided by', 'C' means 'minus' and 'D' means 'plus', then what will be the value of following expression?

11 A 4 C 18 B 6 D 6 = ?

- Ans
1. 51
 2. 47
 3. 45
 4. 42

Question ID : 630680507460
Option 1 ID : 6306801983284
Option 2 ID : 6306801983283
Option 3 ID : 6306801983282
Option 4 ID : 6306801983281
Status : Answered
Chosen Option : 2

Q.16 Based on the statement given below, identify the total amount spent by a university in 10 years.

Statement I:- The University purchased 100 items worth Rs 100 in a month.

Statement II:- The University purchased 20 benches for a total of Rs 100 in a month

- Ans
1. Only statement I is required to answer.
 2. Both the statements are insufficient to answer.
 3. Both Statement I and Statement II are required to answer the question.
 4. Only statement II is required to answer.

Question ID : 630680507456
Option 1 ID : 6306801983265
Option 2 ID : 6306801983268
Option 3 ID : 6306801983266
Option 4 ID : 6306801983267
Status : Answered
Chosen Option : 2

Q.17 Which among the following option will replace the question mark on the basis of crop and its type?

Rabi : wheat :: Rice : ?

- Ans
1. Both Kharif and Zaid
 2. Kharif
 3. Zaid
 4. Rabi

Question ID : 630680507453
Option 1 ID : 6306801983256
Option 2 ID : 6306801983253
Option 3 ID : 6306801983255
Option 4 ID : 6306801983254
Status : Answered
Chosen Option : 2

Q.18 Which among the following option is correct on the basis of statement and courses of action?

Statement: The wheat crops have been affected by the hail storm for the year 2023- 24 in majority of states in India.

Courses of Action:

I. Compensation should be given only to those farmers whose crops are more than 60 percent rotten.

II. The Government should do a proper survey to find out the percentage of wheat crop being rotten.

- Ans
1. Both I and II follow
 2. Only II follows
 3. Neither I nor II follows
 4. Only I follows

Question ID : 630680507458
Option 1 ID : 6306801983275
Option 2 ID : 6306801983274
Option 3 ID : 6306801983276
Option 4 ID : 6306801983273
Status : Answered
Chosen Option : 2

Q.19 If $K > L > M > N > O$, then which among the following is biggest in this series?

- Ans
1. N
 2. K
 3. M
 4. O

Question ID : 630680507450
Option 1 ID : 6306801983243
Option 2 ID : 6306801983241
Option 3 ID : 6306801983242
Option 4 ID : 6306801983244
Status : Answered
Chosen Option : 2

Q.20 Ranjita is 26th from the top and 8th from the bottom in the class. How many girls are there in the class?

- Ans
1. 32
 2. 34
 3. 36
 4. 33

Question ID : 630680507438
Option 1 ID : 6306801983193
Option 2 ID : 6306801983195
Option 3 ID : 6306801983196
Option 4 ID : 6306801983194
Status : Answered
Chosen Option : 4

Q.21 Six women Asmita, Vinni, Chanda, Daya, Neerja, and Roshni are sitting in a row facing north. Chanda is sitting immediately between Asmita and Neerja. Vinni is sitting immediately to the right of Neerja. Roshni is not sitting at the right end of the row. If Daya is sitting at the right end of the row, then who is sitting on the immediate right side of Chanda?

- Ans
1. Chanda
 2. Daya
 3. Neerja
 4. Vinni

Question ID : 630680507434
Option 1 ID : 6306801983178
Option 2 ID : 6306801983180
Option 3 ID : 6306801983179
Option 4 ID : 6306801983177
Status : Answered
Chosen Option : 3

Q.22 How is the husband of the only daughter of Salma's father's wife related to Salma's mother?

- Ans
1. Son in law
 2. Brother
 3. Father in law
 4. Son

Question ID : 630680507441
Option 1 ID : 6306801983207
Option 2 ID : 6306801983208
Option 3 ID : 6306801983205
Option 4 ID : 6306801983206
Status : Answered
Chosen Option : 1

Q.23 In a certain code language, SKY is written as 55 and AIR is written as 28. How WATER will be written in the same code?

- Ans
1. 68
 2. 65
 3. 66
 4. 67

Question ID : 630680507439
Option 1 ID : 6306801983200
Option 2 ID : 6306801983197
Option 3 ID : 6306801983198
Option 4 ID : 6306801983199
Status : Answered
Chosen Option : 4

Q.24 How many such numbers are there in the series which are immediately followed by letters?

7 @ F 6 # N ! K % 8 \$ R 4 % G 4 K 6 J @ 8 \$ N

- Ans
1. 2
 2. 3
 3. 1
 4. 4

Question ID : 630680507445
Option 1 ID : 6306801983221
Option 2 ID : 6306801983224
Option 3 ID : 6306801983222
Option 4 ID : 6306801983223
Status : Answered
Chosen Option : 4

Q.25 Six women Asmita, Vinni, Chanda, Daya, Neerja, and Roshni are sitting in a row facing north. Chanda is sitting immediately between Asmita and Neerja. Vinni is sitting immediately to the right of Neerja. Roshni is not sitting at the right end of the row. If Daya is sitting at the right end of the row, then who is sitting between Asmita and Neerja?

- Ans
1. Chanda
 2. Neerja
 3. Vinni
 4. Daya

Question ID : 630680507435
Option 1 ID : 6306801983182
Option 2 ID : 6306801983183
Option 3 ID : 6306801983181
Option 4 ID : 6306801983184
Status : Answered
Chosen Option : 1

Q.26 Which among the following option is correct on the basis of the statements and conclusions given below (Statement is based on heights of 5 person namely Sunil, Rahul Rakesh, Vikash, Mansi)?

Statement :-
Sunil>Rahul>Rakesh>Vikash>Mansi

Conclusion I:- Rahul is the shortest.
Conclusion II:- Rahul is the tallest.

- Ans
1. Both conclusion I and II
 2. Only II conclusion follow
 3. Only I conclusion follow
 4. Neither conclusion I nor II

Question ID : 630680507451
Option 1 ID : 6306801983247
Option 2 ID : 6306801983246
Option 3 ID : 6306801983245
Option 4 ID : 6306801983248
Status : Answered
Chosen Option : 4

Q.27 Read the given statement(s) and conclusions carefully. Assuming that the information given in the statements is true, even if it appears to be at variance with commonly known facts, decide which of the given conclusions logically follow(s) from the statement(s).

Statements:

No watermelon is cashew.

No cashew is Mango.

Some apple are mango

Conclusion:

I. No Mango is watermelon

II. No mango is cashew

III. Some cashew are watermelon

IV. All mangoes are watermelon

- Ans
1. Only II
 2. Only I and II
 3. Only I
 4. Only III and IV

Question ID : 630680507442

Option 1 ID : 6306801983210

Option 2 ID : 6306801983212

Option 3 ID : 6306801983209

Option 4 ID : 6306801983211

Status : Answered

Chosen Option : 1

Q.28 If 'A' means 'multiplied by', 'B' means 'divided by', 'C' means 'minus' and 'D' means "plus", then what will be the value of following expression?

12 A 5 C 16 B 2 D 10 = ?

- Ans
1. 66
 2. 62
 3. 58
 4. 70

Question ID : 630680507461

Option 1 ID : 6306801983287

Option 2 ID : 6306801983286

Option 3 ID : 6306801983285

Option 4 ID : 6306801983288

Status : Answered

Chosen Option : 2

Q.29 How many numbers are there in the series which are preceded and followed by symbols?

A @ 5 \$ F H & 9 % L 1 & & L 6 ! N 7 H D A \$ 6

- Ans
1. 2
 2. 1
 3. 0
 4. 3

Question ID : 630680507449

Option 1 ID : 6306801983239

Option 2 ID : 6306801983238

Option 3 ID : 6306801983237

Option 4 ID : 6306801983240

Status : Answered

Chosen Option : 1

Q.30 How many such symbols are there in the series which are immediately preceded and followed by numbers?

D # 5 G 6 3 # 7 @ V \$ J 8 % K 3 & H 5 ! N 9 ^

- Ans
- 1. 1
 - 2. 0
 - 3. 3
 - 4. 2

Question ID : 630680507448
 Option 1 ID : 6306801983234
 Option 2 ID : 6306801983233
 Option 3 ID : 6306801983236
 Option 4 ID : 6306801983235
 Status : Answered
 Chosen Option : 1

Q.31 What will come in place of the question marks (?) to make the series given below logically complete?

89, 78, 69, 58, 49, 38, ?

- Ans
- 1. 18
 - 2. 28
 - 3. 37
 - 4. 29

Question ID : 630680507464
 Option 1 ID : 6306801983300
 Option 2 ID : 6306801983298
 Option 3 ID : 6306801983297
 Option 4 ID : 6306801983299
 Status : Answered
 Chosen Option : 4

Q.32 How many such letters are there in the series which are immediately followed by numbers?

\$ R 7 N # 7 J \$ C 2 % N 3 @ 7 H 8 F \$ 7 V # 2

- Ans
- 1. 6
 - 2. 4
 - 3. 5
 - 4. 3

Question ID : 630680507446
 Option 1 ID : 6306801983228
 Option 2 ID : 6306801983225
 Option 3 ID : 6306801983226
 Option 4 ID : 6306801983227
 Status : Answered
 Chosen Option : 2

Q.33 In a class total number of students is 42. From below, Sarita's rank is 26. What is her rank from the top?

- Ans
1. 17
 2. 20
 3. 19
 4. 18

Question ID : 630680507436
Option 1 ID : 6306801983185
Option 2 ID : 6306801983188
Option 3 ID : 6306801983187
Option 4 ID : 6306801983186
Status : Answered
Chosen Option : 1

Q.34 What will come in the place of question marks (??) to make the following series logically complete?

ZA 1, YB 11, XC 111, WD 1111, ??

- Ans
1. UE 11111
 2. EV 11111
 3. EU 11111
 4. VE 11111

Question ID : 630680507457
Option 1 ID : 6306801983271
Option 2 ID : 6306801983270
Option 3 ID : 6306801983272
Option 4 ID : 6306801983269
Status : Answered
Chosen Option : 4

Section : Domain Knowledge

Q.1

Part of the winding is common to both the primary and secondary circuits
two windings are not electrically isolated

- Ans
- 1.
 - 2.
 - 3.
 - 4.

Question ID : 630680506989
Option 1 ID : 6306801981461
Option 2 ID : 6306801981464
Option 3 ID : 6306801981462
Option 4 ID : 6306801981463
Status : Answered
Chosen Option : 4

Q.2

- Ans
- 1.
 - 2.
 - 3.
 - 4.

Question ID : 630680507070
Option 1 ID : 6306801981787
Option 2 ID : 6306801981786
Option 3 ID : 6306801981785
Option 4 ID : 6306801981788
Status : Answered
Chosen Option : 2

Q.3

- Ans
- 1.
 - 2.
 - 3.
 - 4.

Question ID : 630680507035
Option 1 ID : 6306801981645
Option 2 ID : 6306801981647
Option 3 ID : 6306801981646
Option 4 ID : 6306801981648
Status : Answered
Chosen Option : 4

Q.4

If that waveform have been subjected to a second order attenuation

n factor is a measure of effectiveness in reducing unwanted harmonics without having to specify the values
order load filter

- Ans
- 1.
 - 2.
 - 3.
 - 4.

Question ID : 630680507064
Option 1 ID : 6306801981762
Option 2 ID : 6306801981764
Option 3 ID : 6306801981761
Option 4 ID : 6306801981763
Status : Answered
Chosen Option : 3

Q.5

- Ans
- 1.
 - 2.
 - 3.
 - 4.

Question ID : 630680507012
Option 1 ID : 6306801981554
Option 2 ID : 6306801981555
Option 3 ID : 6306801981553
Option 4 ID : 6306801981556
Status : Answered
Chosen Option : 1

Q.6

- Ans
- 1.
 - 2.
 - 3.
 - 4.

Question ID : 630680507058
Option 1 ID : 6306801981737
Option 2 ID : 6306801981739
Option 3 ID : 6306801981738
Option 4 ID : 6306801981740
Status : Answered
Chosen Option : 1

Q.7

- Ans
- ergence theorem helps us in replacing a surface integral by a volume integral and vice versa
- 1.
 - 2.
 - 3.
 - 4.

Question ID : 630680507048
Option 1 ID : 6306801981697
Option 2 ID : 6306801981700
Option 3 ID : 6306801981698
Option 4 ID : 6306801981699
Status : Answered
Chosen Option : 4

Q.8

- Ans
- 1.
 - 2.
 - 3.
 - 4.

Question ID : 630680507042
 Option 1 ID : 6306801981675
 Option 2 ID : 6306801981676
 Option 3 ID : 6306801981673
 Option 4 ID : 6306801981674
 Status : Answered
 Chosen Option : 4

Q.9

ion transformers may be installed outdoors on overhead poles (pole-mount), outdoors at ground level on
 ount transformers), indoors within buildings, or underground in manholes and vaults

- Ans
- 1.
 - 2.
 - 3.
 - 4.

Question ID : 630680507013
 Option 1 ID : 6306801981557
 Option 2 ID : 6306801981560
 Option 3 ID : 6306801981559
 Option 4 ID : 6306801981558
 Status : Answered
 Chosen Option : 1

Q.10

expression of KVL is $\sum_{j=1}^k v_j = 0$ (where, v_j represent the voltage drop of the element in any given closed
 ch is assumed to have 'k' element)

- Ans
- 1.
 - 2.
 - 3.
 - 4.

Question ID : 630680507019
 Option 1 ID : 6306801981581
 Option 2 ID : 6306801981584
 Option 3 ID : 6306801981583
 Option 4 ID : 6306801981582
 Status : Answered
 Chosen Option : 3

Q.11

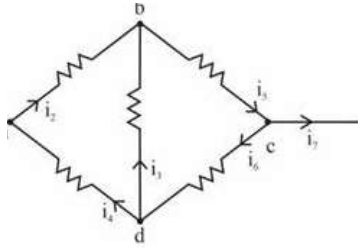

node 'a' $i_1 + i_4 = i_2$

node 'c' $i_5 = i_6 + i_7$

node 'b' $i_2 + i_3 = i_5$

Ans

- 1.
- 2.
- 3.
- 4.

Question ID : 630680507020
 Option 1 ID : 6306801981585
 Option 2 ID : 6306801981587
 Option 3 ID : 6306801981586
 Option 4 ID : 6306801981588
 Status : Answered
 Chosen Option : 4

Q.12

Ans

- 1.
- 2.
- 3.
- 4.



Question ID : 630680507056
 Option 1 ID : 6306801981729
 Option 2 ID : 6306801981732
 Option 3 ID : 6306801981730
 Option 4 ID : 6306801981731
 Status : Answered
 Chosen Option : 1

Q.13

Permittivity of a medium is $\epsilon = \epsilon_r \epsilon_0$

- Ans
- 1.
 - 2.
 - 3.
 - 4.

Question ID : 630680507051
Option 1 ID : 6306801981711
Option 2 ID : 6306801981712
Option 3 ID : 6306801981710
Option 4 ID : 6306801981709
Status : Answered
Chosen Option : 1

Q.14

Open circuit (OC) or No-load Test: The purpose of this test is to determine the shunt branch parameters of the circuit of the transformer

- Ans
- 1.
 - 2.
 - 3.
 - 4.

Question ID : 630680507001
Option 1 ID : 6306801981512
Option 2 ID : 6306801981509
Option 3 ID : 6306801981511
Option 4 ID : 6306801981510
Status : Answered
Chosen Option : 3

Q.15

Forced force cooled: In this type a plain tank is used and oil is cooled artificially, either by tube immersed in which cool water is forced or preferably by circulating the oil by a pump through an extra cooler

- Ans
- 1.
 - 2.
 - 3.
 - 4.

Question ID : 630680506991
Option 1 ID : 6306801981471
Option 2 ID : 6306801981472
Option 3 ID : 6306801981469
Option 4 ID : 6306801981470
Status : Answered
Chosen Option : 1

Q.16

- Ans
- 1.
 - 2.
 - 3.
 - 4.

Question ID : 630680507038
Option 1 ID : 6306801981657
Option 2 ID : 6306801981659
Option 3 ID : 6306801981658
Option 4 ID : 6306801981660
Status : Answered
Chosen Option : 1

Q.17

- Ans
- 1.
 - 2.
 - 3.
 - 4.

Question ID : 630680507016
Option 1 ID : 6306801981572
Option 2 ID : 6306801981570
Option 3 ID : 6306801981569
Option 4 ID : 6306801981571
Status : Not Answered
Chosen Option : --

Q.18

- Ans
- 1.
 - 2.
 - 3.
 - 4.

Question ID : 630680507015
Option 1 ID : 6306801981565
Option 2 ID : 6306801981568
Option 3 ID : 6306801981566
Option 4 ID : 6306801981567
Status : Answered
Chosen Option : 4

Q.19

Electric strength of oil depends almost entirely on its freedom from moisture and suspended fibrous particles and electric strength is virtually a test for purity in this respect

Ans

- 1.
- 2.
- 3.
- 4.

Question ID : 630680507033
Option 1 ID : 6306801981638
Option 2 ID : 6306801981637
Option 3 ID : 6306801981639
Option 4 ID : 6306801981640
Status : Answered
Chosen Option : 2

Q.20

Fundamental process in a nuclear reactor is the chain reaction of fissile material

Ans

- 1.
- 2.
- 3.
- 4.

Question ID : 630680507018
Option 1 ID : 6306801981579
Option 2 ID : 6306801981578
Option 3 ID : 6306801981577
Option 4 ID : 6306801981580
Status : Answered
Chosen Option : 2

Q.21

Operating charges of stations are very small

Ans

- 1.
- 2.
- 3.
- 4.

Question ID : 630680507017
Option 1 ID : 6306801981574
Option 2 ID : 6306801981576
Option 3 ID : 6306801981575
Option 4 ID : 6306801981573
Status : Answered
Chosen Option : 1

Q.22

Ans

- 1.
- 2.
- 3.
- 4.

Question ID : 630680507063
Option 1 ID : 6306801981758
Option 2 ID : 6306801981760
Option 3 ID : 6306801981759
Option 4 ID : 6306801981757
Status : Answered
Chosen Option : 4

Q.23

_____ transformation is a very powerful method of solving linear differential equations

Ans

- 1.
- 2.
- 3.
- 4.

Question ID : 630680507025
Option 1 ID : 6306801981606
Option 2 ID : 6306801981608
Option 3 ID : 6306801981607
Option 4 ID : 6306801981605
Status : Answered
Chosen Option : 3

Q.24

Direction of 'ds' is always that of the outward normal, perpendicular to the surface 'ds' and directed away from

Ans

- 1.
- 2.
- 3.
- 4.

Question ID : 630680507047
Option 1 ID : 6306801981696
Option 2 ID : 6306801981694
Option 3 ID : 6306801981695
Option 4 ID : 6306801981693
Status : Answered
Chosen Option : 2

Q.25

- Ans
- 1.
 - 2.
 - 3.
 - 4.

Question ID : 630680507066
Option 1 ID : 6306801981770
Option 2 ID : 6306801981769
Option 3 ID : 6306801981772
Option 4 ID : 6306801981771
Status : Answered
Chosen Option : 1

Q.26

Method automatically takes care of initial conditions without the necessity of first determining the general solution and then obtain from it a particular solution.

- Ans
- 1.
 - 2.
 - 3.
 - 4.

Question ID : 630680507026
Option 1 ID : 6306801981610
Option 2 ID : 6306801981611
Option 3 ID : 6306801981612
Option 4 ID : 6306801981609
Status : Answered
Chosen Option : 2

Q.27

- Ans
- 1.
 - 2.
 - 3.
 - 4.

Question ID : 630680507054
Option 1 ID : 6306801981721
Option 2 ID : 6306801981724
Option 3 ID : 6306801981722
Option 4 ID : 6306801981723
Status : Not Answered
Chosen Option : --

Q.28

- Ans
- 1.
 - 2.
 - 3.
 - 4.

Question ID : 630680506988
Option 1 ID : 6306801981460
Option 2 ID : 6306801981457
Option 3 ID : 6306801981458
Option 4 ID : 6306801981459
Status : Answered
Chosen Option : 2

Q.29

- Ans
- 1.
 - 2.
 - 3.
 - 4.

Question ID : 630680507004
Option 1 ID : 6306801981521
Option 2 ID : 6306801981524
Option 3 ID : 6306801981523
Option 4 ID : 6306801981522
Status : Answered
Chosen Option : 1

Q.30

- Ans
- 1.
 - 2.
 - 3.
 - 4.

Question ID : 630680507032
Option 1 ID : 6306801981635
Option 2 ID : 6306801981633
Option 3 ID : 6306801981636
Option 4 ID : 6306801981634
Status : Answered
Chosen Option : 4

Q.31

Best detection method

Wohm bridge

Ans

- 1.
- 2.
- 3.
- 4.

Question ID : 630680507045
 Option 1 ID : 6306801981686
 Option 2 ID : 6306801981688
 Option 3 ID : 6306801981685
 Option 4 ID : 6306801981687
 Status : Not Answered
 Chosen Option : --

Q.32

Which induction motor has maintenance is very low

Slip ring induction motor – maintenance is high because there are brushes, brush gears etc.

Ans

- 1.
- 2.
- 3.
- 4.

Question ID : 630680506993
 Option 1 ID : 6306801981479
 Option 2 ID : 6306801981478
 Option 3 ID : 6306801981480
 Option 4 ID : 6306801981477
 Status : Answered
 Chosen Option : 1

Q.33

The loading of a potential transformer is quite similar to that of a power transformer but the loading of a potential transformer is always small, sometimes only a few volt-ampere

Ans

- 1.
- 2.
- 3.
- 4.

Question ID : 630680507041
 Option 1 ID : 6306801981672
 Option 2 ID : 6306801981669
 Option 3 ID : 6306801981670
 Option 4 ID : 6306801981671
 Status : Answered
 Chosen Option : 4

Q.34

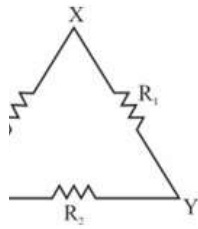

What will be the value of resistance 'R_x' in equivalent star network like?

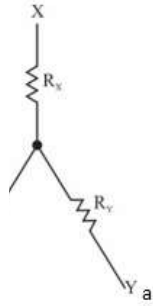

Ans

1. $\frac{R_1 + R_2 + R_3}{3}$
2. $\frac{R_1 + R_2 + R_3}{2}$
3. $\frac{R_1 + R_2 + R_3}{4}$
4. $\frac{R_1 + R_2 + R_3}{6}$

Question ID : 630680507024

Option 1 ID : 6306801981602

Option 2 ID : 6306801981601

Option 3 ID : 6306801981604

Option 4 ID : 6306801981603

Status : Answered

Chosen Option : 2

Q.35

Ans

- 1.
- 2.
- 3.
- 4.

Question ID : 630680507067

Option 1 ID : 6306801981773

Option 2 ID : 6306801981774

Option 3 ID : 6306801981775

Option 4 ID : 6306801981776

Status : Answered

Chosen Option : 3

Q.36

- Ans
- 1.
 - 2.
 - 3.
 - 4.

Question ID : 630680507014
 Option 1 ID : 6306801981564
 Option 2 ID : 6306801981561
 Option 3 ID : 6306801981563
 Option 4 ID : 6306801981562
 Status : Answered
 Chosen Option : 4

Q.37

It is a four layer semiconductor device of pnpn structure with three p-n junctions
 three terminals anode, cathode, and gate

- Ans
- 1.
 - 2.
 - 3.
 - 4.

Question ID : 630680507059
 Option 1 ID : 6306801981743
 Option 2 ID : 6306801981741
 Option 3 ID : 6306801981742
 Option 4 ID : 6306801981744
 Status : Answered
 Chosen Option : 1

Q.38

- Ans
- 1.
 - 2.
 - 3.
 - 4.

Question ID : 630680507034
 Option 1 ID : 6306801981641
 Option 2 ID : 6306801981644
 Option 3 ID : 6306801981642
 Option 4 ID : 6306801981643
 Status : Answered
 Chosen Option : 1

Q.39

- Ans
- 1.
 - 2.
 - 3.
 - 4.

Question ID : 630680506990
 Option 1 ID : 6306801981467
 Option 2 ID : 6306801981466
 Option 3 ID : 6306801981468
 Option 4 ID : 6306801981465
 Status : Answered
 Chosen Option : 4

Q.40

Disadvantage of the De Sauty's Bridge is its simplicity but this advantage is nullified by the fact that it is impossible to measure capacitance if both the capacitors are not free from dielectric loss

- Ans
- 1.
 - 2.
 - 3.
 - 4.

Question ID : 630680507043
 Option 1 ID : 6306801981678
 Option 2 ID : 6306801981680
 Option 3 ID : 6306801981679
 Option 4 ID : 6306801981677
 Status : Not Answered
 Chosen Option : --

Q.41

Compared to a common emitter circuit, a common collector circuit requires only a single input signal. There is no second breakdown problem as with BJTs

- Ans
- 1.
 - 2.
 - 3.
 - 4.

Question ID : 630680507061
 Option 1 ID : 6306801981751
 Option 2 ID : 6306801981749
 Option 3 ID : 6306801981752
 Option 4 ID : 6306801981750
 Status : Answered
 Chosen Option : 2

Q.42

- Ans
- 1.
 - 2.
 - 3.
 - 4.

Question ID : 630680507002
Option 1 ID : 6306801981515
Option 2 ID : 6306801981514
Option 3 ID : 6306801981516
Option 4 ID : 6306801981513
Status : Answered
Chosen Option : 2

Q.43

- Ans
- 1.
 - 2.
 - 3.
 - 4.

Question ID : 630680507060
Option 1 ID : 6306801981746
Option 2 ID : 6306801981747
Option 3 ID : 6306801981748
Option 4 ID : 6306801981745
Status : Answered
Chosen Option : 2

Q.44

- Ans
- 1.
 - 2.
 - 3.
 - 4.

Question ID : 630680507027
Option 1 ID : 6306801981616
Option 2 ID : 6306801981613
Option 3 ID : 6306801981614
Option 4 ID : 6306801981615
Status : Answered
Chosen Option : 2

Q.45

- Ans
- 1.
 - 2.
 - 3.
 - 4.

Question ID : 630680507028
 Option 1 ID : 6306801981617
 Option 2 ID : 6306801981620
 Option 3 ID : 6306801981618
 Option 4 ID : 6306801981619
 Status : Answered
 Chosen Option : 3

Q.46

ating loads needing flywheel action
 nger pumps
 ears and conveyors

- Ans
- 1.
 - 2.
 - 3.
 - 4.

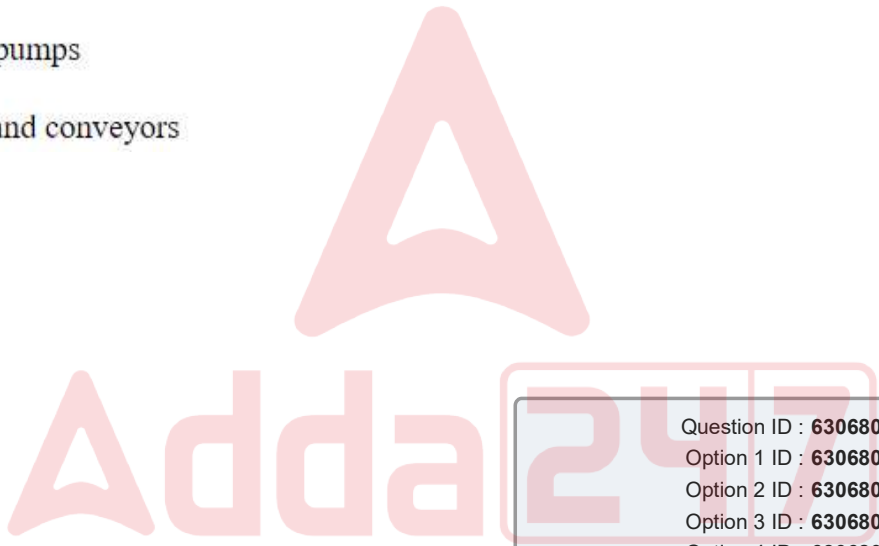

Question ID : 630680506997
 Option 1 ID : 6306801981494
 Option 2 ID : 6306801981495
 Option 3 ID : 6306801981496
 Option 4 ID : 6306801981493
 Status : Answered
 Chosen Option : 3

Q.47

- Ans
- 1.
 - 2.
 - 3.
 - 4.

Question ID : 630680507068
 Option 1 ID : 6306801981779
 Option 2 ID : 6306801981780
 Option 3 ID : 6306801981777
 Option 4 ID : 6306801981778
 Status : Not Attempted and Marked For Review
 Chosen Option : --

Q.48

- Ans
- 1.
 - 2.
 - 3.
 - 4.

Question ID : 630680507011
Option 1 ID : 6306801981552
Option 2 ID : 6306801981549
Option 3 ID : 6306801981551
Option 4 ID : 6306801981550
Status : Answered
Chosen Option : 4

Q.49

inverter output voltage

-pulse-width modulation – The harmonic content can be reduced by using several pulses in each half-cycle
voltage

- Ans
- 1.
 - 2.
 - 3.
 - 4.

Question ID : 630680507062
Option 1 ID : 6306801981754
Option 2 ID : 6306801981755
Option 3 ID : 6306801981756
Option 4 ID : 6306801981753
Status : Answered
Chosen Option : 2

Q.50

- Ans
- 1.
 - 2.
 - 3.
 - 4.

Question ID : 630680506995
Option 1 ID : 6306801981486
Option 2 ID : 6306801981488
Option 3 ID : 6306801981485
Option 4 ID : 6306801981487
Status : Answered
Chosen Option : 2

Q.51

- Ans
- 1.
 - 2.
 - 3.
 - 4.

Question ID : 630680506996
 Option 1 ID : 6306801981490
 Option 2 ID : 6306801981492
 Option 3 ID : 6306801981489
 Option 4 ID : 6306801981491
 Status : Answered
 Chosen Option : 1

Q.52

- Ans
- 1.
 - 2.
 - 3.
 - 4.

Question ID : 630680507030
 Option 1 ID : 6306801981626
 Option 2 ID : 6306801981627
 Option 3 ID : 6306801981628
 Option 4 ID : 6306801981625
 Status : Answered
 Chosen Option : 4

Q.53

- Ans
- 1.
 - 2.
 - 3.
 - 4.

Question ID : 630680507005
 Option 1 ID : 6306801981528
 Option 2 ID : 6306801981527
 Option 3 ID : 6306801981525
 Option 4 ID : 6306801981526
 Status : Answered
 Chosen Option : 4

Q.54

- Ans
- 1.
 - 2.
 - 3.
 - 4.

Question ID : 630680507000
Option 1 ID : 6306801981506
Option 2 ID : 6306801981505
Option 3 ID : 6306801981507
Option 4 ID : 6306801981508
Status : Answered
Chosen Option : 2

Q.55

ng torque is higher and is three times the full load torque

ing current is lower and is two times the full load current

- Ans
- 1.
 - 2.
 - 3.
 - 4.

Question ID : 630680506994
Option 1 ID : 6306801981482
Option 2 ID : 6306801981484
Option 3 ID : 6306801981481
Option 4 ID : 6306801981483
Status : Answered
Chosen Option : 3

Q.56

re finding increasing applications in medium-power applications such as dc and ac motor drives, power
luid-state relays and contractors.

- Ans
- 1.
 - 2.
 - 3.
 - 4.

Question ID : 630680507072
Option 1 ID : 6306801981795
Option 2 ID : 6306801981796
Option 3 ID : 6306801981793
Option 4 ID : 6306801981794
Status : Answered
Chosen Option : 1

Q.57

tion type wattmeter consists of two electromagnets

n aluminium disc is mounted between two magnets

- Ans
- 1.
 - 2.
 - 3.
 - 4.

Question ID : 630680507039
Option 1 ID : 6306801981663
Option 2 ID : 6306801981664
Option 3 ID : 6306801981662
Option 4 ID : 6306801981661
Status : Answered
Chosen Option : 1

Q.58

's premises

atial areas, 120/240-V, single-phase, three-wire service is the most common, where lighting loads and outlets
by 120-V, single-phase connections, and large household appliances such as electric ranges, clothes dryers,
's, and electric space heating are supplied by 240-V, single-phase connections

- Ans
- 1.
 - 2.
 - 3.
 - 4.

Question ID : 630680507010
Option 1 ID : 6306801981548
Option 2 ID : 6306801981545
Option 3 ID : 6306801981546
Option 4 ID : 6306801981547
Status : Answered
Chosen Option : 4

Q.59

- Ans
- 1.
 - 2.
 - 3.
 - 4.

Question ID : 630680507037
Option 1 ID : 6306801981654
Option 2 ID : 6306801981653
Option 3 ID : 6306801981656
Option 4 ID : 6306801981655
Status : Answered
Chosen Option : 2

Q.60

Insulating layer DC current cannot flow through the capacitor as it blocks it allowing instead a voltage to be across the plates in the form of an electrical charge

Ans

- 1.
- 2.
- 3.
- 4.

Question ID : 630680507057
Option 1 ID : 6306801981734
Option 2 ID : 6306801981736
Option 3 ID : 6306801981733
Option 4 ID : 6306801981735
Status : Answered
Chosen Option : 4

Q.61

Ans

- 1.
- 2.
- 3.
- 4.

Question ID : 630680507050
Option 1 ID : 6306801981705
Option 2 ID : 6306801981708
Option 3 ID : 6306801981706
Option 4 ID : 6306801981707
Status : Answered
Chosen Option : 4

Q.62

standing feature of a DC shunt motor however is its superb wide range flexible speed control above and base speed using solid-state controlled rectifiers.

Ans

- 1.
- 2.
- 3.
- 4.

Question ID : 630680506998
Option 1 ID : 6306801981499
Option 2 ID : 6306801981498
Option 3 ID : 6306801981500
Option 4 ID : 6306801981497
Status : Answered
Chosen Option : 2

Q.63

When the controlling variables are not a part of the network under investigation

controlling variable is part of the network being examined additional care must be taken when applying the nodal analysis technique

Ans

- 1.
- 2.
- 3.
- 4.

Question ID : 630680507031
 Option 1 ID : 6306801981630
 Option 2 ID : 6306801981632
 Option 3 ID : 6306801981631
 Option 4 ID : 6306801981629
 Status : Answered
 Chosen Option : 2

Q.64

Ans

- 1.
- 2.
- 3.
- 4.

Question ID : 630680507009
 Option 1 ID : 6306801981541
 Option 2 ID : 6306801981543
 Option 3 ID : 6306801981542
 Option 4 ID : 6306801981544
 Status : Answered
 Chosen Option : 1

Q.65

Switching speed is very high and the on-resistance is of the order of milliohms.

MOSFETs find increasing applications in low-power high frequency converters.

Ans



- 1.
- 2.
- 3.
- 4.

Question ID : 630680507071
 Option 1 ID : 6306801981791
 Option 2 ID : 6306801981792
 Option 3 ID : 6306801981789
 Option 4 ID : 6306801981790
 Status : Answered
 Chosen Option : 1

Q.66

(y, z) = Distance between the current element and the point)

Ans

1. 
2. 
3. 
4. 

Question ID : 630680507052
 Option 1 ID : 6306801981715
 Option 2 ID : 6306801981716
 Option 3 ID : 6306801981713
 Option 4 ID : 6306801981714
 Status : Answered
 Chosen Option : 4

Q.67

Ans

1. 
2. 
3. 
4. 

Question ID : 630680507046
 Option 1 ID : 6306801981690
 Option 2 ID : 6306801981691
 Option 3 ID : 6306801981689
 Option 4 ID : 6306801981692
 Status : Answered
 Chosen Option : 1

Q.68

is applicable for line currents, sheet currents or volume currents

Ans

- 1.
- 2.
- 3.
- 4.

Question ID : 630680507055
Option 1 ID : 6306801981726
Option 2 ID : 6306801981728
Option 3 ID : 6306801981727
Option 4 ID : 6306801981725
Status : Answered
Chosen Option : 3

Q.69

Ans

- 1.
- 2.
- 3.
- 4.

Question ID : 630680507053
Option 1 ID : 6306801981718
Option 2 ID : 6306801981720
Option 3 ID : 6306801981717
Option 4 ID : 6306801981719
Status : Answered
Chosen Option : 3

Q.70

Ans

- 1.
- 2.
- 3.
- 4.

Question ID : 630680507040
Option 1 ID : 6306801981666
Option 2 ID : 6306801981665
Option 3 ID : 6306801981667
Option 4 ID : 6306801981668
Status : Answered
Chosen Option : 1

Q.71

- Ans
- 1.
 - 2.
 - 3.
 - 4.

Question ID : 630680507065
Option 1 ID : 6306801981768
Option 2 ID : 6306801981767
Option 3 ID : 6306801981765
Option 4 ID : 6306801981766
Status : Answered
Chosen Option : 4

Q.72

- Ans
- 1.
 - 2.
 - 3.
 - 4.

Question ID : 630680506999
Option 1 ID : 6306801981504
Option 2 ID : 6306801981503
Option 3 ID : 6306801981501
Option 4 ID : 6306801981502
Status : Answered
Chosen Option : 4

Q.73

o indicates the law of conservation of charges and can also be stated as at any node of a circuit, at every me, the sum of incoming currents is equal to the sum of outgoing currents

- Ans
- 1.
 - 2.
 - 3.
 - 4.

Question ID : 630680507021
Option 1 ID : 6306801981590
Option 2 ID : 6306801981591
Option 3 ID : 6306801981592
Option 4 ID : 6306801981589
Status : Answered
Chosen Option : 2

Q.74

in's double bridge method

entiometer method

- Ans
- 1.
 - 2.
 - 3.
 - 4.

Question ID : 630680507044
Option 1 ID : 6306801981683
Option 2 ID : 6306801981681
Option 3 ID : 6306801981684
Option 4 ID : 6306801981682
Status : Answered
Chosen Option : 2

Q.75

- Ans
- 1.
 - 2.
 - 3.
 - 4.

Question ID : 630680507008
Option 1 ID : 6306801981540
Option 2 ID : 6306801981539
Option 3 ID : 6306801981537
Option 4 ID : 6306801981538
Status : Not Answered
Chosen Option : --

Q.76

- Ans
- 1.
 - 2.
 - 3.
 - 4.

Question ID : 630680507007
Option 1 ID : 6306801981536
Option 2 ID : 6306801981534
Option 3 ID : 6306801981533
Option 4 ID : 6306801981535
Status : Not Answered
Chosen Option : --

Q.77

- Ans
- 1.
 - 2.
 - 3.
 - 4.

Question ID : **630680507036**
Option 1 ID : **6306801981650**
Option 2 ID : **6306801981649**
Option 3 ID : **6306801981652**
Option 4 ID : **6306801981651**
Status : **Answered**
Chosen Option : **1**

Q.78

- Ans
- 1.
 - 2.
 - 3.
 - 4.

Question ID : **630680507069**
Option 1 ID : **6306801981784**
Option 2 ID : **6306801981783**
Option 3 ID : **6306801981782**
Option 4 ID : **6306801981781**
Status : **Answered**
Chosen Option : **1**

Q.79

- Ans
- 1.
 - 2.
 - 3.
 - 4.

Question ID : **630680507029**
Option 1 ID : **6306801981624**
Option 2 ID : **6306801981621**
Option 3 ID : **6306801981622**
Option 4 ID : **6306801981623**
Status : **Answered**
Chosen Option : **2**

Q.80

id change of Energy flow

gligible sheath loss

) skin effect

Ans

- 1.
- 2.
- 3.
- 4.

Question ID : 630680507003
 Option 1 ID : 6306801981519
 Option 2 ID : 6306801981517
 Option 3 ID : 6306801981518
 Option 4 ID : 6306801981520
 Status : **Not Attempted and Marked For Review**
 Chosen Option : --

Q.81

ators also prevent short circuiting between the different phase conductors and provide necessary mechanical the line conductors

Ans

- 1.
- 2.
- 3.
- 4.

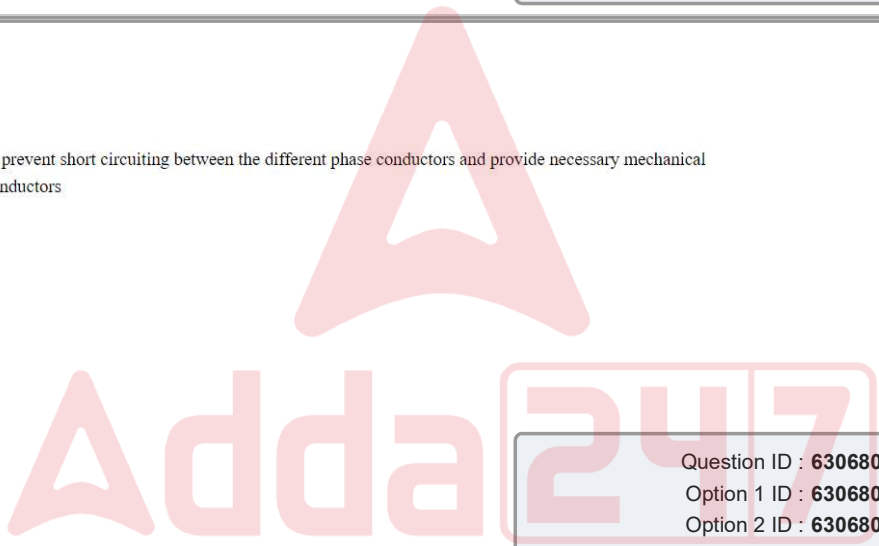

Question ID : 630680507006
 Option 1 ID : 6306801981532
 Option 2 ID : 6306801981531
 Option 3 ID : 6306801981530
 Option 4 ID : 6306801981529
 Status : **Answered**
 Chosen Option : 2

Q.82

connection also be termed as 'T' connection

lta connection can be termed as ' π '(pie) connection

- Ans
- 1.
 - 2.
 - 3.
 - 4.

Question ID : 630680507023
Option 1 ID : 6306801981600
Option 2 ID : 6306801981598
Option 3 ID : 6306801981597
Option 4 ID : 6306801981599
Status : Answered
Chosen Option : 4

Q.83

direction of force is along the line joining the charges

force depends upon the medium in which the charges are placed.

- Ans
- 1.
 - 2.
 - 3.
 - 4.

Question ID : 630680507049
Option 1 ID : 6306801981703
Option 2 ID : 6306801981701
Option 3 ID : 6306801981704
Option 4 ID : 6306801981702
Status : Answered
Chosen Option : 1

Q.84

tion points

shes

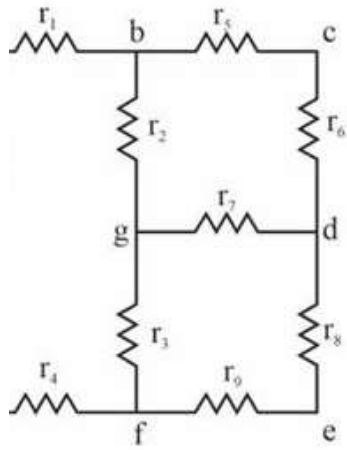

Ans

- 1.
- 2.
- 3.
- 4.

Question ID : 630680507022
 Option 1 ID : 6306801981596
 Option 2 ID : 6306801981593
 Option 3 ID : 6306801981594
 Option 4 ID : 6306801981595
 Status : Answered
 Chosen Option : 2

Q.85

Ans

- 1.
- 2.
- 3.
- 4.

Question ID : 630680506992
 Option 1 ID : 6306801981476
 Option 2 ID : 6306801981474
 Option 3 ID : 6306801981473
 Option 4 ID : 6306801981475
 Status : Answered
 Chosen Option : 3