

116224710

NARMADA

Test Booklet Code

46

ENGLISH

Do not open this Test Booklet until you are asked to do so.

This Booklet contains 32 pages, including Rough Page.

Test Booklet No.

Important Instructions:

1. The Answer Sheet is inside this Test Booklet. When you are directed to open the Test Booklet, take out the Answer Sheet and fill in the particulars on ORIGINAL Copy carefully with blue/black ball point pen only.
2. The test is of 3 hours duration and the Test Booklet contains 180 multiple-choice questions (four options with a single correct answer) from Physics, Chemistry and Biology (Botany and Zoology).
3. Wherever the symbols/constants are not mentioned, they are to be considered as per their standard meaning/value.
4. Each question carries 4 marks. For each correct response, the candidate will get 4 marks. For each incorrect response, one mark will be deducted from the total scores. The maximum marks are 720.
5. Use Blue/Black Ball Point Pen only for writing particulars on this page/markings responses on Answer Sheet.
6. Rough work is to be done in the space provided for this purpose in the Test Booklet only.
7. On completion of the test, the candidate must hand over the Answer Sheet (ORIGINAL and OFFICE Copy) to the Invigilator before leaving the Room/Hall. The candidates are allowed to take away this Test Booklet with them.
8. The CODE for this Booklet is "46". Make sure to enter this code in the OMR answer sheet.

9. The candidates should ensure that the Answer Sheet is not folded. Do not make any stray marks on the Answer Sheet. Do not write your Roll No. anywhere else except in the specified space in the Test Booklet/ Answer Sheet.
10. Use of white fluid for correction is NOT permissible on the Answer Sheet.
11. Each candidate must show on-demand his/her Admit Card to the Invigilator.
12. No candidate, without special permission of the centre Superintendent or Invigilator, would leave his/her seat.
13. The candidates should not leave the Examination Hall without handing over their Answer Sheet to the Invigilator on duty and sign (with time) the Attendance Sheet twice. Cases, where a candidate has not signed the Attendance Sheet second time, will be deemed not to have handed over the Answer Sheet and dealt with as an Unfair Means case.
14. Use of Electronic/Manual Calculator is prohibited.
15. The candidates are governed by all Rules and Regulations of the examination with regard to their conduct in the Examination Room/Hall. All cases of unfair means will be dealt with as per the Rules and Regulations of this examination along with Public Examinations (Prevention of unfair means act 2024).
16. No part of the Test Booklet and Answer Sheet shall be detached under any circumstances.
17. The candidates will write the Correct Test Booklet Code as given in the Test Booklet/Answer Sheet in the Attendance Sheet.
18. If a candidate marks more than one answers for a question in the OMR Sheet, it will be treated as incorrect and negative marking will be applicable.

Name of the Candidate (in Capitals) : UTKARSH RAJ

Roll Number : in figures 2302105302

: in words

Centre of Examination (in Capitals) : PM SHRI GOVT SR SEC SCHOOL SEC 4/2

Candidate's Signature : Utkarsh Raj

Invigilator's Signature

Facsimile signature stamp of Centre Superintendent :

46_English]

1

[Contd...

Centre Superintendent
Centre No. 2302105
PM Shri G.S.S.S. Sec-47 Gurugram

- 1 A physical quantity P is related to four observations a, b, c and d as follows:

$$P = a^3 b^2 / c \sqrt{d}$$

The percentage errors of measurement in a, b, c and d are 1%, 3%, 2%, and 4% respectively. The percentage error in the quantity P is

- (1) 2% (2) 13%
(3) 15% (4) 10%

- 2 The intensity of transmitted light when a polaroid sheet, placed between two crossed polaroids at 22.5° from the polarization axis of one of the polaroid, is (I_0 is the intensity of polarised light after passing through the first polaroid):

- (1) $\frac{I_0}{4}$ (2) $\frac{I_0}{8}$
(3) $\frac{I_0}{16}$ (4) $\frac{I_0}{2}$

- 3 A 2 amp current is flowing through two different small circular copper coils having radii ratio 1:2. The ratio of their respective magnetic moments will be

- (1) 1:2 (2) 2:1
(3) 4:1 (4) 1:4

- 4 Consider the diameter of a spherical object being measured with the help of a Vernier callipers. Suppose its 10 Vernier Scale Divisions (V.S.D.) are equal to its 9 Main Scale Divisions (M.S.D.). The least division in the M.S. is 0.1 cm and the zero of V.S. is at $x = 0.1$ cm when the jaws of Vernier callipers are closed.

If the main scale reading for the diameter is $M = 5$ cm and the number of coinciding vernier division is 8, the measured diameter after zero error correction, is

- (1) 5.08 cm. (2) 4.98 cm
(3) 5.00 cm (4) 5.18 cm

- 5 A photon and an electron (mass m) have the same energy E . The ratio $(\lambda_{\text{photon}} / \lambda_{\text{electron}})$ of their de Broglie wavelengths is: (c is the speed of light)

- (1) $c\sqrt{2mE}$ (2) $c\sqrt{\frac{2m}{E}}$
(3) $\frac{1}{c}\sqrt{\frac{E}{2m}}$ (4) $\sqrt{\frac{E}{2m}}$

- 6 De-Broglie wavelength of an electron orbiting in the $n = 2$ state of hydrogen atom is close to (Given Bohr radius = 0.052 nm)

- (1) 0.67 nm (2) 1.67 nm
(3) 2.67 nm (4) 0.067 nm

- 7 An unpolarized light beam travelling in air is incident on a medium of refractive index 1.73 at Brewster's angle. Then-

- (1) reflected light is partially polarized and the angle of reflection is close to 30°
(2) both reflected and transmitted light are perfectly polarized with angles of reflection and refraction close to 60° and 30° , respectively.
(3) transmitted light is completely polarized with angle of refraction close to 30°
(4) reflected light is completely polarized and the angle of reflection is close to 60°

- 8 The kinetic energies of two similar cars A and B are 100 J and 225 J respectively. On applying breaks, car A stops after 1000 m and car B stops after 1500 m. If F_A and F_B are the forces applied by the breaks on cars A and B, respectively, then the ratio F_A / F_B is

- (1) $\frac{2}{3}$ (2) $\frac{1}{3}$
(3) $\frac{1}{2}$ (4) $\frac{3}{2}$

9 A wire of resistance R is cut into 8 equal pieces. From these pieces two equivalent resistances are made by adding four of these together in parallel. Then these two sets are added in series. The net effective resistance of the combination is :

- (1) $\frac{R}{32}$ (2) $\frac{R}{16}$
 (3) $\frac{R}{8}$ (4) $\frac{R}{64}$

10 An oxygen cylinder of volume 30 litre has 18.20 moles of oxygen. After some oxygen is withdrawn from the cylinder, its gauge pressure drops to 11 atmospheric pressure at temperature 27°C . The mass of the oxygen withdrawn from the cylinder is nearly equal to:

- [Given, $R = \frac{100}{12} \text{ J mol}^{-1}\text{K}^{-1}$, and molecular mass of $\text{O}_2 = 32$,
 1 atm pressure = $1.01 \times 10^5 \text{ N/m}^2$]
 (1) 0.144 kg (2) 0.116 kg
 (3) 0.156 kg (4) 0.125 kg

11 In a certain camera, a combination of four similar thin convex lenses are arranged axially in contact. Then the power of the combination and the total magnification in comparison to the power (p) and magnification (m) for each lens will be, respectively

- (1) p^4 and $4m$ (2) $4p$ and m^4
 (3) p^4 and m^4 (4) $4p$ and $4m$

12 AB is a part of an electrical circuit (see figure). The potential difference " $V_A - V_B$ ", at the instant when current $i = 2 \text{ A}$ and is increasing at a rate of 1 amp / second is:

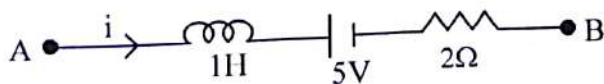

- (1) 6 volt (2) 9 volt
 (3) 10 volt (4) 5 volt

13 A body weighs 48 N on the surface of the earth. The gravitational force experienced by the body due to the earth, at a height equal to one-third the radius of the earth from its surface is :

- (1) 27 N (2) 32 N
 (3) 36 N (4) 16 N

14 A full wave rectifier circuit with diodes (D_1) and (D_2) is shown in the figure. If input supply voltage $V_{in} = 220\sin(100\pi t)$ volt, then at $t = 15 \text{ msec}$

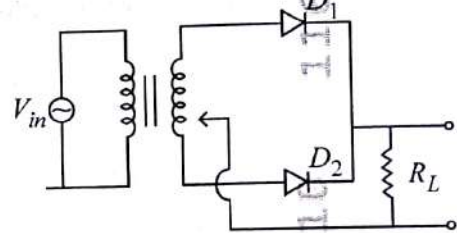

- (1) D_1 is reverse biased, D_2 is forward biased
 (2) D_1 and D_2 both are forward biased
 (3) D_1 and D_2 both are reverse biased
 (4) D_1 is forward biased, D_2 is reverse biased

15 Two cities X and Y are connected by a regular bus service with a bus leaving in either direction every T min. A girl is driving scooter with a speed of 60 km/h in the direction X to Y notices that a bus goes past her every 30 minutes in the direction of her motion, and every 10 minutes in the opposite direction. Choose the correct option for the period T of the bus service and the speed (assumed constant) of the buses.

- (1) 25 min, 100 km/h
 (2) 10 min, 90 km/h
 (3) 15 min, 120 km/h
 (4) 9 min, 40 km/h

- 16 The Sun rotates around its centre once in 27 days. What will be the period of revolution if the Sun were to expand to twice its present radius without any external influence? Assume the Sun to be a sphere of uniform density.
- (1) 105 days (2) 115 days
(3) 108 days (4) 100 days

- 17 The electric field in a plane electromagnetic wave is given by

$$E_z = 60 \cos(5x + 1.5 \times 10^9 t) \text{ V/m}$$

Then expression for the corresponding magnetic field is (here subscripts denote the direction of the field) :

- (1) $B_x = 2 \times 10^{-7} \cos(5x + 1.5 \times 10^9 t) T$
 (2) $B_z = 60 \cos(5x + 1.5 \times 10^9 t) T$
 (3) $B_y = 60 \sin(5x + 1.5 \times 10^9 t) T$
 (4) $B_y = 2 \times 10^{-7} \cos(5x + 1.5 \times 10^9 t) T$

- 18 Two identical charged conducting spheres A and B have their centres separated by a certain distance. Charge on each sphere is q and the force of repulsion between them is F . A third identical uncharged conducting sphere is brought in contact with sphere A first and then with B and finally removed from both. New force of repulsion between spheres A and B (Radii of A and B are negligible compared to the distance of separation so that for calculating force between them they can be considered as point charges) is best given as :

- (1) $\frac{2F}{3}$ (2) $\frac{F}{2}$
 (3) $\frac{3F}{8}$ (4) $\frac{3F}{5}$

46_English]

- 19 An electric dipole with dipole moment $5 \times 10^{-6} \text{ Cm}$ is aligned with the direction of a uniform electric field of magnitude $4 \times 10^5 \text{ N/C}$. The dipole is then rotated through an angle of 60° with respect to the electric field. The change in the potential energy of the dipole is :

- (1) 1.0 J (2) 1.2 J
(3) 1.5 J (4) 0.8 J

- 20 A microscope has an objective of focal length 2 cm, eyepiece of focal length 4 cm and the tube length of 40 cm. If the distance of distinct vision of eye is 25 cm, the magnification in the microscope is

- (1) 125 (2) 150
(3) 250 (4) 100

- 21 The output (Y) of the given logic implementation is similar to the output of an _____ gate.

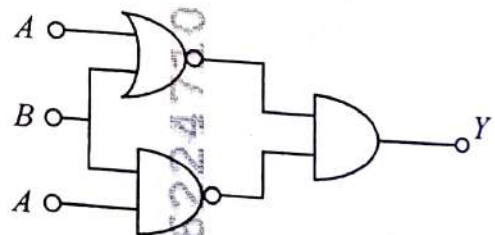

- (1) NAND
(2) OR
(3) NOR
(4) AND

22 A uniform rod of mass 20 kg and length 5 m leans against a smooth vertical wall making an angle of 60° with it. The other end rests on a rough horizontal floor. The friction force that the floor exerts on the rod is (take $g = 10 \text{ m/s}^2$)

- (1) $100\sqrt{3} \text{ N}$ (2) 200 N
 (3) $200\sqrt{3} \text{ N}$ (4) 100 N

23 The current passing through the battery in the given circuit, is:

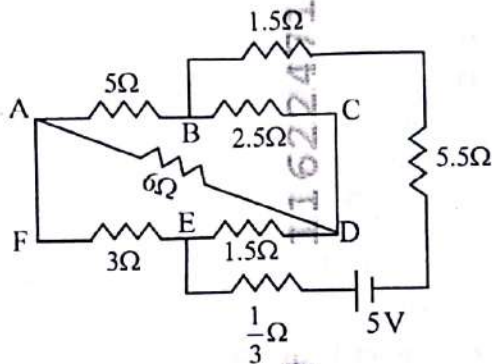

- (1) 0.5 A (2) 2.5 A
 (3) 1.5 A (4) 2.0 A

24 A model for quantized motion of an electron in a uniform magnetic field B states that the flux passing through the orbit of the electron is $n(h/e)$ where n is an integer, h is Planck's constant and e is the magnitude of electron's charge. According to the model, the magnetic moment of an electron in its lowest energy state will be (m is the mass of the electron)

- (1) $\frac{he}{2\pi m}$ (2) $\frac{heB}{\pi m}$
 (3) $\frac{heB}{2\pi m}$ (4) $\frac{he}{\pi m}$

25 Which of the following options represent the variation of photoelectric current with property of light shown on the x-axis?

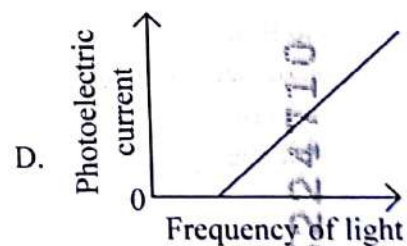
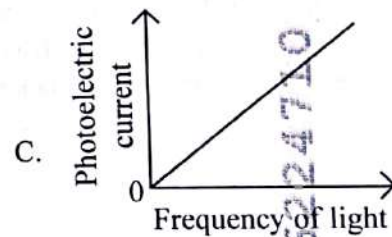
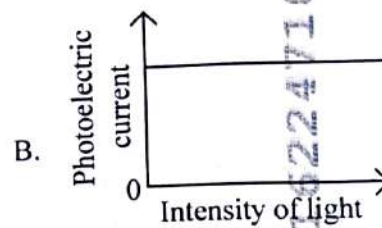
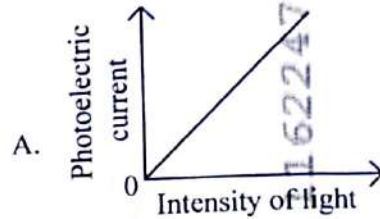

- (1) A and C (2) A and D
 (3) B and D (4) A only

26 An electron (mass 9×10^{-31} kg and charge 1.6×10^{-19} C) moving with speed $c/100$ ($c =$ speed of light) is injected into a magnetic field \vec{B} of magnitude 9×10^{-4} T perpendicular to its direction of motion. We wish to apply a uniform electric field \vec{E} together with the magnetic field so that the electron does not deflect from its path. Then (speed of light $c = 3 \times 10^8$ ms $^{-1}$)

- (1) \vec{E} is perpendicular to \vec{B} and its magnitude is 27×10^2 V m $^{-1}$
- (2) \vec{E} is parallel to \vec{B} and its magnitude is 27×10^2 V m $^{-1}$
- (3) \vec{E} is parallel to \vec{B} and its magnitude is 27×10^4 V m $^{-1}$
- (4) \vec{E} is perpendicular to \vec{B} and its magnitude is 27×10^4 V m $^{-1}$

27 Consider a water tank shown in the figure. It has one wall at $x = L$ and can be taken to be very wide in the z direction. When filled with a liquid of surface tension S and density ρ , the liquid surface makes angle θ_0 ($\theta_0 \ll 1$) with the x -axis at $x = L$. If $y(x)$ is the height of the surface then the equation for $y(x)$ is :

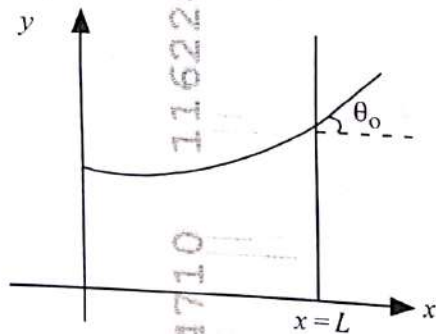

(take $\theta(x) = \sin \theta(x) = \tan \theta(x) = \frac{dy}{dx}$, g is the acceleration due to gravity)

- (1) $\frac{d^2 y}{dx^2} = \frac{\rho g}{S} y$
- (2) $\frac{d^2 y}{dx^2} = \sqrt{\frac{\rho g}{S}}$
- (3) $\frac{dy}{dx} = \sqrt{\frac{\rho g}{S}} x$
- (4) $\frac{d^2 y}{dx^2} = \frac{\rho g}{S} x$

46_English]

28 A pipe open at both ends has a fundamental frequency f in air. The pipe is now dipped vertically in a water drum to half of its length. The fundamental frequency of the air column is now equal to :

- (1) f
- (2) $\frac{3f}{2}$
- (3) $2f$
- (4) $\frac{f}{2}$

29 A parallel plate capacitor made of circular plates is being charged such that the surface charge density on its plates is increasing at a constant rate with time. The magnetic field arising due to displacement current is :

- (1) constant between the plates and zero outside the plates
- (2) non-zero everywhere with maximum at the imaginary cylindrical surface connecting peripheries of the plates
- (3) zero between the plates and non-zero outside
- (4) zero at all places

30 Three identical heat conducting rods are connected in series as shown in the figure. The rods on the sides have thermal conductivity $2K$ while that in the middle has thermal conductivity K . The left end of the combination is maintained at temperature $3T$ and the right end at T . The rods are thermally insulated from outside. In steady state, temperature at the left junction is T_1 and that at the right junction is T_2 . The ratio T_1/T_2 is

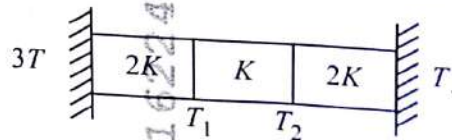

- (1) $\frac{4}{3}$
- (2) $\frac{5}{3}$
- (3) $\frac{5}{4}$
- (4) $\frac{3}{2}$

6

[Contd...

- 31 A constant voltage of 50 V is maintained between the points A and B of the circuit shown in the figure. The current through the branch CD of the circuit is :

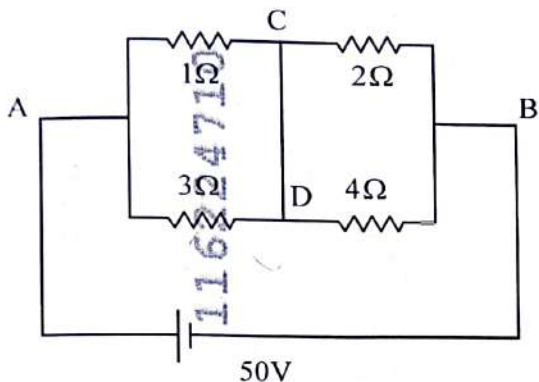

- (1) 2.0 A (2) 2.5 A
 (3) 3.0 A (4) 1.5 A
- 32 In some appropriate units, time (t) and position (x) relation of a moving particle is given by $t = x^2 + x$. The acceleration of the particle is

- (1) $-\frac{2}{(2x+1)^3}$ (2) $+\frac{2}{(x+1)^3}$
 (3) $+\frac{2}{2x+1}$ (4) $-\frac{2}{(x+2)^3}$

- 33 Two gases A and B are filled at the same pressure in separate cylinders with movable pistons of radius r_A and r_B , respectively. On supplying an equal amount of heat to both the systems reversibly under constant pressure, the pistons of gas A and B are displaced by 16 cm and 9 cm, respectively. If the change in their internal energy is the same, then the ratio

- $\frac{r_A}{r_B}$ is equal to
- (1) $\frac{3}{4}$ (2) $\frac{2}{\sqrt{3}}$
 (3) $\frac{\sqrt{3}}{2}$ (4) $\frac{4}{3}$

- 34 In an oscillating spring mass system, a spring is connected to a box filled with sand. As the box oscillates, sand leaks slowly out of the box vertically so that the average frequency $\omega(t)$ and average amplitude $A(t)$ of the system change with time t . Which one of the following options schematically depicts these changes correctly?

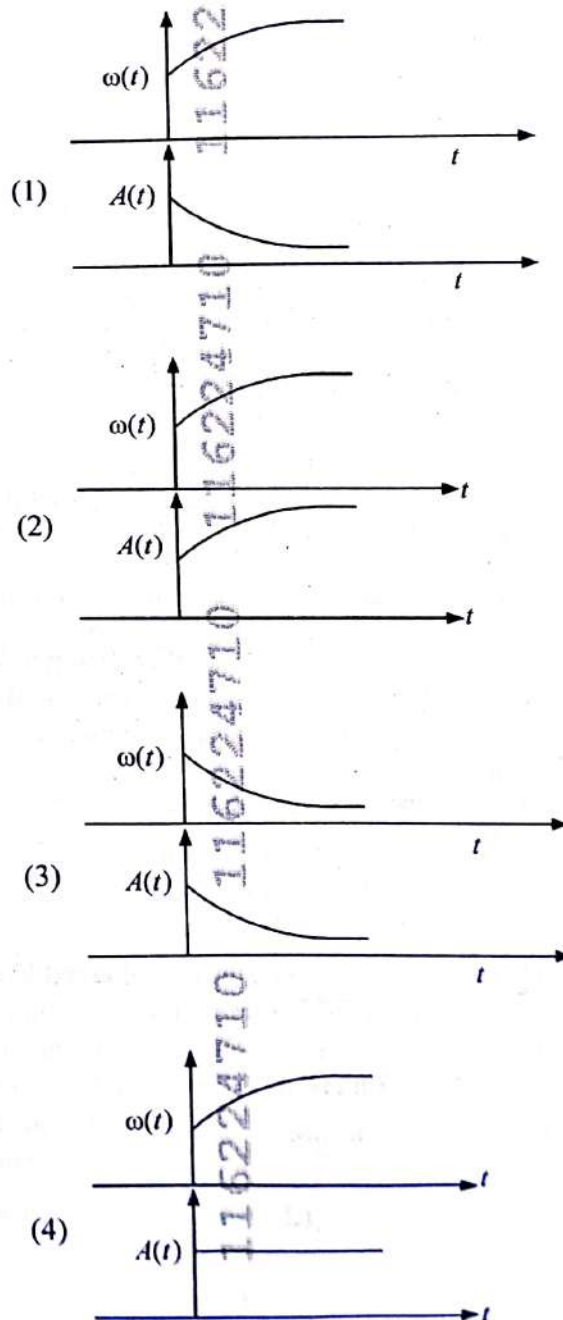

- 35 A sphere of radius R is cut from a larger solid sphere of radius $2R$ as shown in the figure. The ratio of the moment of inertia of the smaller sphere to that of the rest part of the sphere about the Y-axis is :

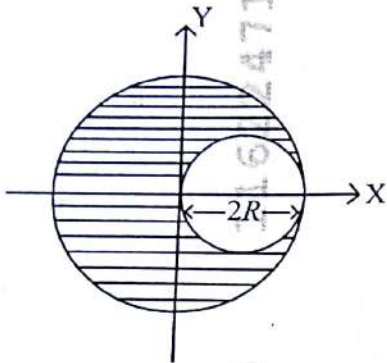

- (1) $\frac{7}{40}$ (2) $\frac{7}{57}$
 (3) $\frac{7}{64}$ (4) $\frac{7}{8}$

- 36 The plates of a parallel plate capacitor are separated by d . Two slabs of different dielectric constant K_1 and K_2 with thickness $\frac{3}{8}d$ and $\frac{d}{2}$, respectively are inserted in the capacitor. Due to this, the capacitance becomes two times larger than when there is nothing between the plates.

If $K_1 = 1.25 K_2$, the value of K_1 is :

- (1) 2.33 (2) 1.60
 (3) 1.33 (4) 2.66

- 37 There are two inclined surfaces of equal length (L) and same angle of inclination 45° with the horizontal. One of them is rough and the other is perfectly smooth. A given body takes 2 times as much time to slide down on rough surface than on the smooth surface. The coefficient of kinetic friction (μ_k) between the object and the rough surface is close to

- (1) 0.40 (2) 0.5
 (3) 0.75 (4) 0.25

- 38 A bob of heavy mass m is suspended by a light string of length l . The bob is given a horizontal velocity v_0 as shown in figure. If the string gets slack at some point P making an angle θ from the horizontal, the ratio of the speed v of the bob at point P to its initial speed v_0 is:

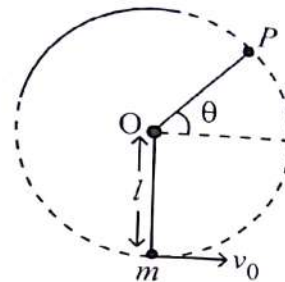

- (1) $\left(\frac{1}{2+3\sin\theta}\right)^{1/2}$
 (2) $\left(\frac{\cos\theta}{2+3\sin\theta}\right)^{1/2}$
 (3) $\left(\frac{\sin\theta}{2+3\sin\theta}\right)^{1/2}$
 (4) $(\sin\theta)^{1/2}$

- 39 A container has two chambers of volumes $V_1 = 2$ litres and $V_2 = 3$ litres separated by a partition made of a thermal insulator. The chambers contains $n_1 = 5$ and $n_2 = 4$ moles of ideal gas at pressures $p_1 = 1$ atm and $p_2 = 2$ atm, respectively. When the partition is removed, the mixture attains an equilibrium pressure of :

- (1) 1.6 atm (2) 1.4 atm
 (3) 1.8 atm (4) 1.3 atm

40 To an ac power supply of 220 V at 50 Hz, a resistor of 20Ω , a capacitor of reactance 25Ω and an inductor of reactance 45Ω are connected in series. The corresponding current in the circuit and the phase angle between the current and the voltage is, respectively -

- (1) 7.8 A and 45°
- (2) 15.6 A and 30°
- (3) 15.6 A and 45°
- (4) 7.8 A and 30°

41 The radius of Martian orbit around the Sun is about 4 times the radius of the orbit of Mercury. The Martian year is 687 Earth days. Then which of the following is the length of 1 year on Mercury ?

- (1) 225 earth days
- (2) 172 earth days
- (3) 124 earth days
- (4) 88 earth days

42 A balloon is made of a material of surface tension S and its inflation outlet (from where gas is filled in it) has small area A . It is filled with a gas of density ρ and takes a spherical shape of radius R . When the gas is allowed to flow freely out of it, its radius r changes from R to 0 (zero) in time T . If the speed $v(r)$ of gas coming out of the balloon depends on r as r^a and $T \propto S^\alpha A^\beta \rho^\gamma R^\delta$ then

- (1) $a = -\frac{1}{2}, \alpha = \frac{1}{2}, \beta = -1, \gamma = -\frac{1}{2}, \delta = \frac{5}{2}$
- (2) $a = -\frac{1}{2}, \alpha = \frac{1}{2}, \beta = -1, \gamma = \frac{1}{2}, \delta = \frac{7}{2}$
- (3) $a = \frac{1}{2}, \alpha = \frac{1}{2}, \beta = -\frac{1}{2}, \gamma = \frac{1}{2}, \delta = \frac{7}{2}$
- (4) $a = \frac{1}{2}, \alpha = \frac{1}{2}, \beta = -1, \gamma = +1, \delta = \frac{3}{2}$

43 A particle of mass m is moving around the origin with a constant force F pulling it towards the origin. If Bohr model is used to describe its motion, the radius r of the n^{th} orbit and the particle's speed v in the orbit depend on n as

- (1) $r \propto n^{1/3}; v \propto n^{2/3}$
- (2) $r \propto n^{2/3}; v \propto n^{1/3}$
- (3) $r \propto n^{4/3}; v \propto n^{-1/3}$
- (4) $r \propto n^{1/3}; v \propto n^{1/3}$

44 Two identical point masses P and Q , suspended from two separate massless springs of spring constants k_1 and k_2 , respectively, oscillate vertically. If their maximum speeds are the same, the ratio (A_Q/A_P) of the amplitude A_Q of mass Q to the amplitude A_P of mass P is:

- (1) $\frac{k_1}{k_2}$
- (2) $\sqrt{\frac{k_2}{k_1}}$
- (3) $\sqrt{\frac{k_1}{k_2}}$
- (4) $\frac{k_2}{k_1}$

45 A ball of mass 0.5 kg is dropped from a height of 40 m. The ball hits the ground and rises to a height of 10 m. The impulse imparted to the ball during its collision with the ground is (Take $g = 9.8 \text{ m/s}^2$)

- (1) 7 NS
- (2) 0
- (3) 84 NS
- (4) 21 NS

[Contd...

46 Given below are two statements :
Statement I : Ferromagnetism is considered as an extreme form of paramagnetism.
Statement II : The number of unpaired electrons in a Cr^{2+} ion ($Z = 24$) is the same as that of a Nd^{3+} ion ($Z = 60$).
 In the light of the above statements, choose the correct answer from the options given below:

- (1) Both Statement I and Statement II are false
- (2) Statement I is true but Statement II is false
- (3) Statement I is false but Statement II is true
- (4) Both Statement I and Statement II are true

47 For the reaction $\text{A(g)} \rightleftharpoons 2\text{B(g)}$, the backward reaction rate constant is higher than the forward reaction rate constant by a factor of 2500, at 1000 K.

[Given : $R = 0.0831 \text{ J atm mol}^{-1} \text{ K}^{-1}$]

K_p for the reaction at 1000 K is

- (1) 2.077×10^5
- (2) 0.033
- (3) 0.021
- (4) 83.1

48 Total number of possible isomers (both structural as well as stereoisomers) of cyclic ethers of molecular formula $\text{C}_4\text{H}_8\text{O}$ is :

- (1) 8
- (2) 10
- (3) 11
- (4) 6

49 Given below are two statements :

Statement I : A hypothetical diatomic molecule with bond order zero is quite stable.

Statement II : As bond order increases, the bond length increases.

In the light of the above statements, choose the most appropriate answer from the options given below :

- (1) Both Statement I and Statement II are false
- (2) Statement I is true but Statement II is false
- (3) Statement I is false but Statement II is true
- (4) Both Statement I and Statement II are true

46_English]

50 Identify the suitable reagent for the following conversion.

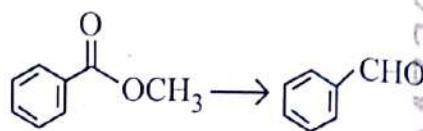

- (1) (i) $\text{AlH}(\text{iBu})_2$ (ii) H_2O
- (2) (i) NaBH_4 , (ii) $\text{H}^+/\text{H}_2\text{O}$
- (3) $\text{H}_2 / \text{Pd-BaSO}_4$
- (4) (i) LiAlH_4 , (ii) $\text{H}^+/\text{H}_2\text{O}$

51 The major product of the following reaction is:

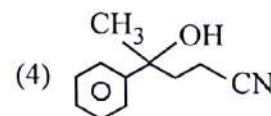
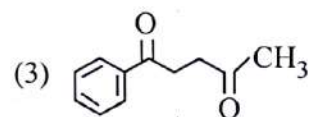
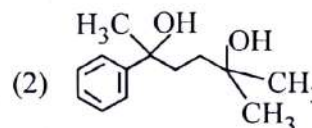
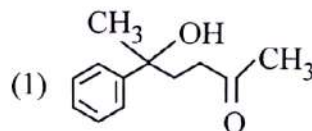
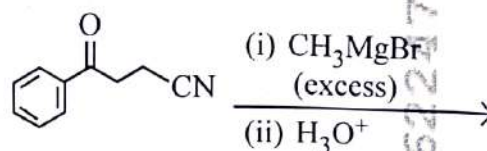

52 If the molar conductivity (Λ_m) of a 0.050 mol L^{-1} solution of a monobasic weak acid is $90 \text{ S cm}^2 \text{ mol}^{-1}$, its extent (degree) of dissociation will be

[Assume $\Lambda_+^\circ = 349.6 \text{ S cm}^2 \text{ mol}^{-1}$ and

$\Lambda_-^\circ = 50.4 \text{ S cm}^2 \text{ mol}^{-1}$.]

- (1) 0.125
- (2) 0.225
- (3) 0.215
- (4) 0.115

53 Which one of the following reactions does NOT belong to "Lassaigne's test"?

- (1) $2\text{Na} + \text{S} \xrightarrow{\Delta} \text{Na}_2\text{S}$
 (2) $\text{Na} + \text{X} \xrightarrow{\Delta} \text{NaX}$
 (3) $2\text{CuO} + \text{C} \xrightarrow{\Delta} 2\text{Cu} + \text{CO}_2$
 (4) $\text{Na} + \text{C} + \text{N} \xrightarrow{\Delta} \text{NaCN}$

54 The correct order of decreasing acidity of the following aliphatic acids is :

- (1) $\text{CH}_3\text{COOH} > (\text{CH}_3)_2\text{CHCOOH} > (\text{CH}_3)_3\text{CCOOH} > \text{HCOOH}$
 (2) $\text{HCOOH} > \text{CH}_3\text{COOH} > (\text{CH}_3)_2\text{CHCOOH} > (\text{CH}_3)_3\text{CCOOH}$
 (3) $\text{HCOOH} > (\text{CH}_3)_3\text{CCOOH} > (\text{CH}_3)_2\text{CHCOOH} > \text{CH}_3\text{COOH}$
 (4) $(\text{CH}_3)_3\text{CCOOH} > (\text{CH}_3)_2\text{CHCOOH} > \text{CH}_3\text{COOH} > \text{HCOOH}$

55 Match List I with List II

List I (Name of Vitamin)	List II (Deficiency disease)
A. Vitamin B ₁₂	I. Cheilosis
B. Vitamin D	II. Convulsions
C. Vitamin B ₂	III. Rickets
D. Vitamin B ₆	IV. Pernicious anaemia

Choose the correct answer from the options given below :

- (1) A-IV, B-III, C-I, D-II
 (2) A-II, B-III, C-I, D-IV
 (3) A-IV, B-III, C-II, D-I
 (4) A-I, B-III, C-II, D-IV

56 Out of the following complex compounds, which of the compound will be having the minimum conductance in solution?

- (1) $[\text{Co}(\text{NH}_3)_4\text{Cl}_2]$
 (2) $[\text{Co}(\text{NH}_3)_6]\text{Cl}_3$
 (3) $[\text{Co}(\text{NH}_3)_5\text{Cl}]\text{Cl}$
 (4) $[\text{Co}(\text{NH}_3)_3\text{Cl}_3]$

57 Sugar 'X'

- A. is found in honey.
 B. is a keto sugar.
 C. exists in α and β anomeric forms.
 D. is laevorotatory.

'X' is :

- (1) D-Fructose (2) Maltose
 (3) Sucrose (4) D-Glucose

58 How many products (including stereoisomers) are expected from monochlorination of the following compound?

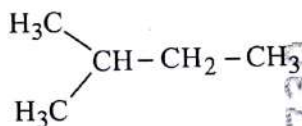

- (1) 3 (2) 5
 (3) 6 (4) 2

59 Which one of the following compounds can exist as cis-trans isomers?

- (1) 2-Methylhex-2-ene
 (2) 1,1-Dimethylcyclopropane
 (3) 1,2-Dimethylcyclohexane
 (4) Pent-1-ene

60 Which one of the following reactions does NOT give benzene as the product?

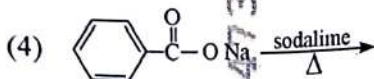
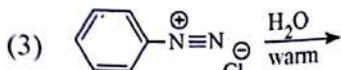
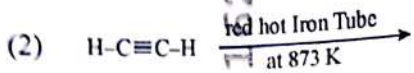
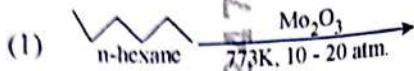

61 Phosphoric acid ionizes in three steps with their ionization constant values

K_{a_1} , K_{a_2} and K_{a_3} , respectively,

while K is the overall ionization constant.

Which of the following statements are true?

A. $\log K = \log K_{a_1} + \log K_{a_2} + \log K_{a_3}$

B. H_3PO_4 is a stronger acid than H_2PO_4^- and HPO_4^{2-} .

C. $K_{a_1} > K_{a_2} > K_{a_3}$

D. $K_{a_1} = \frac{K_{a_3} + K_{a_2}}$

Choose the correct answer from the options given below:

- (1) A and C only
- (2) B, C and D only
- (3) A, B and C only
- (4) A and B only

46_English]

62 Among the following, choose the ones with equal number of atoms.

- A. 212 g of Na_2CO_3 (s) [molar mass = 106 g]
- B. 248 g of Na_2O (s) [molar mass = 62 g]
- C. 240 g of NaOH (s) [molar mass = 40 g]
- D. 12 g of H_2 (g) [molar mass = 2 g]
- E. 220 g of CO_2 (g) [molar mass = 44 g]

Choose the correct answer from the options given below :

- (1) A, B, and D only
- (2) B, C, and D only
- (3) B, D, and E only
- (4) A, B, and C only

63 Given below are two statements :

Statement I : Like nitrogen that can form ammonia, arsenic can form arsine.

Statement II : Antimony cannot form antimony pentoxide.

In the light of the above statements, choose the most appropriate answer from the options given below

- (1) Both Statement I and Statement II are incorrect
- (2) Statement I is correct but Statement II is incorrect
- (3) Statement I is incorrect but Statement II is correct
- (4) Both Statement I and Statement II are correct

64 Dalton's Atomic theory could not explain which of the following?

- (1) Law of constant proportion
- (2) Law of multiple proportion
- (3) Law of gaseous volume
- (4) Law of conservation of mass

65 The correct order of decreasing basic strength of the given amines is :

- (1) N-ethylethanamine > ethanamine > benzenamine > N-methylaniline
- (2) N-ethylethanamine > ethanamine > N-methylaniline > benzenamine
- (3) benzenamine > ethanamine > N-methylaniline > N-ethylethanamine
- (4) N-methylaniline > benzenamine > ethanamine > N-ethylethanamine

66 Which of the following statements are true?

- A. Unlike Ga that has a very high melting point, Cs has a very low melting point.
- B. On Pauling scale, the electronegativity values of N and Cl are not the same.
- C. Ar, K⁺, Cl⁻, Ca²⁺, and S²⁻ are all isoelectronic species.
- D. The correct order of the first ionization enthalpies of Na, Mg, Al, and Si is Si > Al > Mg > Na.
- E. The atomic radius of Cs is greater than that of Li and Rb.

Choose the **correct** answer from the options given below :

- (1) C and E only
- (2) C and D only
- (3) A, C, and E only
- (4) A, B, and E only

67 Match List - I with List - II

- | List-I | List-II |
|----------------------|--|
| A. XeO ₃ | I. sp ³ d; linear |
| B. XeF ₂ | II. sp ³ ; pyramidal |
| C. XeOF ₄ | III. sp ³ d ³ ; distorted octahedral |
| D. XeF ₆ | IV. sp ³ d ² ; square pyramidal |

Choose the **correct** answer from the options given below :

- (1) A-II, B-I, C-III, D-IV
- (2) A-IV, B-II, C-III, D-I
- (3) A-IV, B-II, C-I, D-III
- (4) A-II, B-I, C-IV, D-III

68 The standard heat of formation, in kcal/mol of Ba²⁺ is :

- [Given : standard heat of formation of SO₄²⁻ ion (aq) = - 216 kcal/mol, standard heat of crystallisation of BaSO₄(s) = - 4.5 kcal/mol, standard heat of formation of BaSO₄(s) = - 349 kcal/mol]
- (1) - 133.0
 - (2) + 133.0
 - (3) + 220.5
 - (4) - 128.5

69 Among the given compounds I-III, the correct order of bond dissociation energy of C-H bond marked with * is :

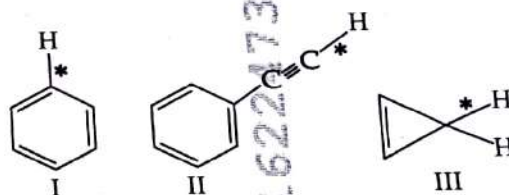

- (1) I > II > III
- (2) III > II > I
- (3) II > III > I
- (4) II > I > III

70 Predict the major product 'P' in the following sequence of reactions -

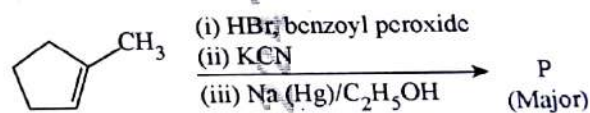

- (1)
- (2)
- (3)
- (4)

71 Match List - I with List - II

List-I	List-II
A. Haber process	I. Fe catalyst
B. Wacker oxidation	II. PdCl ₂
C. Wilkinson catalyst	III. [(PPh ₃) ₃ RhCl]
D. Ziegler catalyst	IV. TiCl ₄ with Al(CH ₃) ₃

Choose the **correct** answer from the options given below :

- (1) A-II, B-III, C-I, D-IV
- (2) A-I, B-II, C-III, D-IV
- (3) A-I, B-IV, C-III, D-II
- (4) A-I, B-II, C-IV, D-III



72 Energy and radius of first Bohr orbit of He⁺ and Li²⁺ are

[Given R_H = 2.18 × 10⁻¹⁸ J, a₀ = 52.9 pm]

- (1) E_n(Li²⁺) = -8.72 × 10⁻¹⁸ J;
r_n(Li²⁺) = 26.4 pm
E_n(He⁺) = 19.62 × 10⁻¹⁸ J;
r_n(He⁺) = 17.6 pm
- (2) E_n(Li²⁺) = -19.62 × 10⁻¹⁶ J;
r_n(Li²⁺) = 17.6 pm
E_n(He⁺) = -8.72 × 10⁻¹⁶ J;
r_n(He⁺) = 26.4 pm
- (3) E_n(Li²⁺) = -8.72 × 10⁻¹⁶ J;
r_n(Li²⁺) = 17.6 pm
E_n(He⁺) = 19.62 × 10⁻¹⁶ J;
r_n(He⁺) = 17.6 pm
- (4) E_n(Li²⁺) = -19.62 × 10⁻¹⁸ J;
r_n(Li²⁺) = 17.6 pm
E_n(He⁺) = -8.72 × 10⁻¹⁸ J;
r_n(He⁺) = 26.4 pm

46_English]

73 Given below are two statements : one is labelled as **Assertion (A)** and the other is labelled as **Reason (R)**.

Assertion (A) :  I undergoes S_N2 reaction faster than  Cl.

Reason (R) : Iodine is a better leaving group because of its large size.

In the light of the above statements, choose the **correct** answer from the options given below:

- (1) Both **A** and **R** are true but **R** is **not** the correct explanation of **A**
- (2) **A** is true but **R** is false
- (3) **A** is false but **R** is true
- (4) Both **A** and **R** are true and **R** is the correct explanation of **A**

74 If the half-life (t_{1/2}) for a first order reaction is 1 minute, then the time required for 99.9% completion of the reaction is closest to :

- (1) 4 minutes
- (2) 5 minutes
- (3) 10 minutes
- (4) 2 minutes

75 Which of the following aqueous solution will exhibit highest boiling point?

- (1) 0.01M KNO₃
- (2) 0.01M Na₂SO₄
- (3) 0.015M C₆H₁₂O₆
- (4) 0.01M Urea

76 Higher yield of NO in N₂(g) + O₂(g) ⇌ 2NO(g) can be obtained at

[ΔH of the reaction = + 180.7 kJ mol⁻¹]

- A. higher temperature
- B. lower temperature
- C. higher concentration of N₂
- D. higher concentration of O₂

Choose the **correct** answer from the options given below:

- (1) B, C only
- (2) B, C, D only
- (3) A, C, D only
- (4) A, D only

77 Match List I with List II

List I (Ion)	List II (Group Number in Cation Analysis)
A. Cr^{2+}	I. Group-I
B. Mg^{2+}	II. Group-III
C. Pb^{2+}	III. Group-IV
D. Al^{3+}	IV. Group-VI

Choose the **correct** answer from the options given below :

- (1) A-III, B-IV, C-I, D-II
- (2) A-III, B-II, C-IV, D-I
- (3) A-III, B-II, C-I, D-IV
- (4) A-III, B-IV, C-II, D-I

78 The ratio of the wavelengths of the light absorbed by a Hydrogen atom when it undergoes $n = 2 \rightarrow n = 3$ and $n = 4 \rightarrow n = 6$ transitions, respectively, is

- (1) $\frac{1}{16}$
- (2) $\frac{1}{9}$
- (3) $\frac{1}{4}$
- (4) $\frac{1}{36}$

79 The correct order of the wavelength of light absorbed by the following complexes is,

- A. $[\text{Co}(\text{NH}_3)_6]^{3+}$ B. $[\text{Co}(\text{CN})_6]^{3-}$
 C. $[\text{Cu}(\text{H}_2\text{O})_4]^{2+}$ D. $[\text{Ti}(\text{H}_2\text{O})_6]^{3+}$

Choose the **correct** answer from the options given below:

- (1) $B < A < D < C$
- (2) $C < D < A < B$
- (3) $C < A < D < B$
- (4) $B < D < A < C$

80 Identify the correct orders against the property mentioned

- A. $\text{H}_2\text{O} > \text{NH}_3 > \text{CHCl}_3$ – dipole moment
- B. $\text{XeF}_4 > \text{XeO}_3 > \text{XeF}_2$ – number of lone pairs on central atom
- C. $\text{O-H} > \text{C-H} > \text{N-O}$ – bond length
- D. $\text{N}_2 > \text{O}_2 > \text{H}_2$ – bond enthalpy

Choose the **correct** answer from the options given below :

- (1) B, D only
- (2) A, C only
- (3) B, C only
- (4) A, D only

81 Match List I with List II

List I (Mixture)	List II (Method of Separation)
A. $\text{CHCl}_3 + \text{C}_6\text{H}_5\text{NH}_2$	I. Distillation under reduced pressure
B. Crude oil in petroleum industry	II. Steam distillation
C. Glycerol from spent-lye	III. Fractional distillation
D. Aniline - water	IV. Simple distillation

Choose the **correct** answer from the options given below :

- (1) A-IV, B-III, C-II, D-I
- (2) A-III, B-IV, C-I, D-II
- (3) A-III, B-IV, C-II, D-I
- (4) A-IV, B-III, C-I, D-II

82 If the rate constant of a reaction is 0.03 s^{-1} , how much time does it take for 7.2 mol L^{-1} concentration of the reactant to get reduced to 0.9 mol L^{-1} ?

(Given: $\log 2 = 0.301$)

- (1) 23.1 s
- (2) 210 s
- (3) 21.0 s
- (4) 69.3 s

83 Which among the following electronic configurations belong to main group elements?

- A. $[\text{Ne}]3s^1$ B. $[\text{Ar}]3d^3 4s^2$
 C. $[\text{Kr}]4d^{10} 5s^2 5p^5$ D. $[\text{Ar}]3d^{10} 4s^1$
 E. $[\text{Rn}]5f^0 6d^2 7s^2$

Choose the **correct** answer from the option given below:

- (1) A and C only
 (2) D and E only
 (3) A, C and D only
 (4) B and E only

84 Match List - I with List - II

List-I (Example)	List-II (Type of Solution)
A. Humidity	I. Solid in solid
B. Alloys	II. Liquid in gas
C. Amalgams	III. Solid in gas
D. Smoke	IV. Liquid in solid

Choose the **correct** answer from the options given below:

- (1) A-II, B-I, C-IV, D-III
 (2) A-III, B-I, C-IV, D-II
 (3) A-III, B-II, C-I, D-IV
 (4) A-II, B-IV, C-I, D-III

85 5 moles of liquid X and 10 moles of liquid Y make a solution having a vapour pressure of 70 torr. The vapour pressures of pure X and Y are 63 torr and 78 torr respectively. Which of the following is true regarding the described solution?

- (1) The solution shows negative deviation.
 (2) The solution is ideal.
 (3) The solution has volume greater than the sum of individual volumes.
 (4) The solution shows positive deviation.

86 $\text{C}(\text{s}) + 2\text{H}_2(\text{g}) \rightarrow \text{CH}_4(\text{g}); \Delta H = -74.8 \text{ kJ mol}^{-1}$
 Which of the following diagrams gives an accurate representation of the above reaction? [R → reactants; P → products]

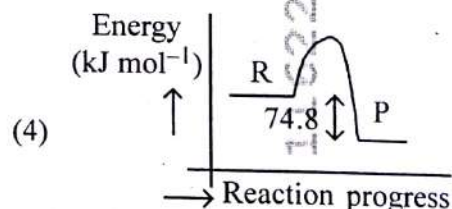
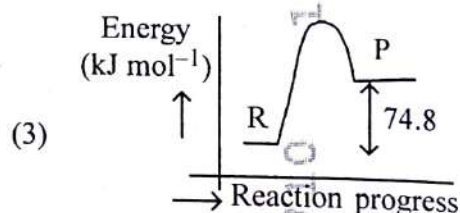
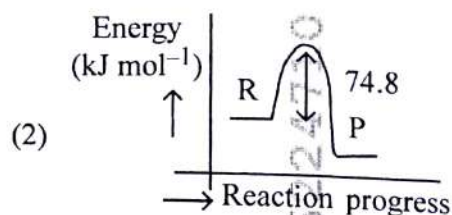
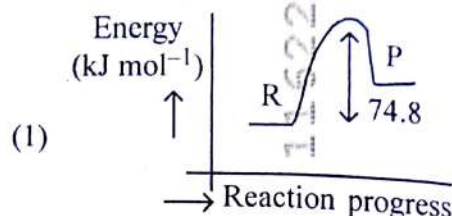

87 Which one of the following compounds **does not** decolorize bromine water?

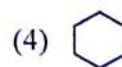
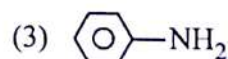
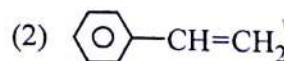
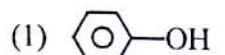

- 88 Consider the following compounds :
 $\underline{\text{K}}\text{O}_2$, $\text{H}_2\underline{\text{O}}_2$ and $\text{H}_2\underline{\text{S}}\text{O}_4$.
 The oxidation states of the underlined elements in them are, respectively,
- (1) +2, -2, and +6
 - (2) +1, -2, and +4
 - (3) +4, -4, and +6
 - (4) +1, -1, and +6

- 89 Given below are two statements :
Statement I : Benzenediazonium salt is prepared by the reaction of aniline with nitrous acid at 273 - 278 K. It decomposes easily in the dry state.

Statement II : Insertion of iodine into the benzene ring is difficult and hence iodobenzene is prepared through the reaction of benzenediazonium salt with KI.

In the light of the above statements, choose the **most appropriate** answer from the options given below :

- (1) Both Statement I and Statement II are incorrect
- (2) Statement I is correct but Statement II is incorrect
- (3) Statement I is incorrect but Statement II is correct
- (4) Both Statement I and Statement II are correct

- 90 Which of the following are paramagnetic?

- A. $[\text{NiCl}_4]^{2-}$ B. $\text{Ni}(\text{CO})_4$
 C. $[\text{Ni}(\text{CN})_4]^{2-}$ D. $[\text{Ni}(\text{H}_2\text{O})_6]^{2+}$
 E. $\text{Ni}(\text{PPh}_3)_4$

Choose the **correct** answer from the options given below:

- (1) B and E only
- (2) A and D only
- (3) A, D and E only
- (4) A and C only

- 91 Match List - I with List - II.

List - I	List - II
A. Progesterone	I. Pars intermedia
B. Relaxin	II. Ovary
C. Melanocyte stimulating hormone	III. Adrenal Medulla
D. Catecholamines	IV. Corpus luteum

Choose the **correct** answer from the options given below :

- (1) A-IV, B-II, C-III, D-I
- (2) A-II, B-IV, C-I, D-III
- (3) A-III, B-II, C-IV, D-I
- (4) A-IV, B-II, C-I, D-III

- 92 The blue and white selectable markers have been developed which differentiate recombinant colonies from non-recombinant colonies on the basis of their ability to produce colour in the presence of a chromogenic substrate.

Given below are two statements about this method:

Statement I : The blue coloured colonies have DNA insert in the plasmid and they are identified as recombinant colonies.

Statement II : The colonies without blue colour have DNA insert in the plasmid and are identified as recombinant colonies.

In the light of the above statements, choose the **most appropriate** answer from the options given below :

- (1) Both Statement I and Statement II are incorrect
- (2) Statement I is correct but Statement II is incorrect
- (3) Statement I is incorrect but Statement II is correct
- (4) Both Statement I and Statement II are correct

93 Given below are two statements : One is labelled as **Assertion (A)** and the other is labelled as **Reason (R)**.

Assertion (A) : Cells of the tapetum possess dense cytoplasm and generally have more than one nucleus.

Reason (R) : Presence of more than one nucleus in the tapetum increases the efficiency of nourishing the developing microspore mother cells.

In light of the above statements, choose the **most appropriate** answer from the options given below :

- (1) Both **A** and **R** are true but **R** is **NOT** the correct explanation of **A**
- (2) **A** is true but **R** is false
- (3) **A** is false but **R** is true
- (4) Both **A** and **R** are true and **R** is the correct explanation of **A**

94 Match **List I** with **List II**.

List I	List II
A. Pteridophyte	I. <i>Salvia</i>
B. Bryophyte	II. <i>Ginkgo</i>
C. Angiosperm	III. <i>Polytrichum</i>
D. Gymnosperm	IV. <i>Salvinia</i>

Choose the option with all **correct** matches.

- (1) A-IV, B-III, C-I, D-II
- (2) A-III, B-IV, C-I, D-II
- (3) A-IV, B-III, C-II, D-I
- (4) A-III, B-IV, C-II, D-I

95 Match **List - I** with **List - II**.

List - I	List - II
A. Heart	I. Erythropoietin
B. Kidney	II. Aldosterone
C. Gastro-intestinal tract	III. Atrial natriuretic factor
D. Adrenal Cortex	IV. Secretin

Choose the **correct** answer from the options given below :

- (1) A-IV, B-III, C-II, D-I
- (2) A-I, B-III, C-IV, D-II
- (3) A-III, B-I, C-IV, D-II
- (4) A-II, B-I, C-III, D-IV

96 Who proposed that the genetic code for amino acids should be made up of three nucleotides?

- (1) Francis Crick
- (2) Jacque Monod
- (3) Franklin Stahl
- (4) George Gamow

97 Which of the following is the unit of productivity of an Ecosystem?

- (1) KCal m^{-2}
- (2) KCal m^{-3}
- (3) $(KCal\ m^{-2})yr^{-1}$
- (4) gm^{-2}

98 Which of the following is an example of a zygomorphic flower?

- | | |
|------------|-------------|
| (1) Datura | (2) Pea |
| (3) Chilli | (4) Petunia |

99 Match **List I** with **List II** :

List I	List II
A. The Evil Quartet	I. Cryopreservation
B. Ex situ conservation	II. Alien species invasion
C. <i>Lantana camara</i>	III. Causes of biodiversity losses
D. Dodo	IV. Extinction

Choose the option with all correct matches.

- (1) A-III, B-I, C-II, D-IV
- (2) A-III, B-IV, C-II, D-I
- (3) A-III, B-II, C-IV, D-I
- (4) A-III, B-II, C-I, D-IV

100 Given below are two statements :
Statement I : In ecosystem, there is unidirectional flow of energy of sun from producers to consumers.

Statement II : Ecosystems are exempted from 2nd law of thermodynamics.

In the light of the above statements, choose the most appropriate answer from the options given below :

- (1) Both statement I and statement II are incorrect
- (2) Statement I is correct but statement II is incorrect
- (3) Statement I is incorrect but statement II is correct
- (4) Both statement I and statement II are correct

101 The protein portion of an enzyme is called :

- (1) Coenzyme
- (2) Apoenzyme
- (3) Prosthetic group
- (4) Cofactor

102 Twins are born to a family that lives next door to you. The twins are a boy and a girl. Which of the following must be true?

- (1) They are fraternal twins.
- (2) They were conceived through in vitro fertilization.
- (3) They have 75% identical genetic content.
- (4) They are monozygotic twins.

103 After maturation, in primary lymphoid organs, the lymphocytes migrate for interaction with antigens to secondary lymphoid organ(s) / tissue(s) like:

- | | |
|--------------------|----------------|
| A. thymus | B. bone marrow |
| C. spleen | D. lymph nodes |
| E. Peyer's patches | |

Choose the correct answer from the options given below:

- | | |
|------------------|------------------|
| (1) A, B, C only | (2) E, A, B only |
| (3) C, D, E only | (4) B, C, D only |

104 In frog, the Renal portal system is a special venous connection that acts to link :

- (1) Liver and kidney
- (2) Kidney and intestine
- (3) Kidney and lower part of body
- (4) Liver and intestine

105 Which of the following enzyme(s) are NOT essential for gene cloning?

- A. Restriction enzymes
- B. DNA ligase
- C. DNA mutase
- D. DNA recombinase
- E. DNA polymerase

Choose the correct answer from the options given below :

- (1) A and B only
- (2) D and E only
- (3) B and C only
- (4) C and D only

106 With the help of given pedigree, find out the probability for the birth of a child having no disease and being a carrier (has the disease mutation in one allele of the gene) in F₃ generation.

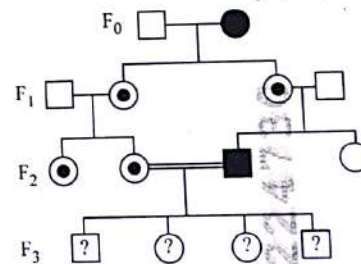

- Unaffected male
- Affected male
- Carrier female
- Unaffected female
- Affected female

- | | |
|----------|---------|
| (1) 1/2 | (2) 1/8 |
| (3) Zero | (4) 1/4 |

- 107 Which one of the following is the characteristic feature of gymnosperms?
 (1) Seeds are naked.
 (2) Seeds are absent.
 (3) Gymnosperms have flowers for reproduction.
 (4) Seeds are enclosed in fruits.
- 108 The first menstruation is called :
 (1) Menarche (2) Diapause
 (3) Ovulation (4) Menopause
- 109 In bryophytes, the gemmae help in which one of the following?
 (1) Asexual reproduction
 (2) Nutrient absorption
 (3) Gaseous exchange
 (4) Sexual reproduction
- 110 How many meiotic and mitotic divisions need to occur for the development of a mature female gametophyte from the megaspore mother cell in an angiosperm plant?
 (1) 1 Meiosis and 2 Mitosis
 (2) 1 Meiosis and 3 Mitosis
 (3) No Meiosis and 2 Mitosis
 (4) 2 Meiosis and 3 Mitosis
- 111 Role of the water-vascular system in Echinoderms is:
 A. Respiration and Locomotion
 B. Excretion and Locomotion
 C. Capture and transport of food
 D. Digestion and Respiration
 E. Digestion and Excretion
 Choose the **correct** answer from the options given below :
 (1) A and C Only
 (2) B and C Only
 (3) B, D and E Only
 (4) A and B Only

- 112 Read the following statements on plant growth and development.
 A. Parthenocarpy can be induced by auxins.
 B. Plant growth regulators can be involved in promotion as well as inhibition of growth.
 C. Dedifferentiation is a pre-requisite for re-differentiation.
 D. Abscisic acid is a plant growth promoter.
 E. Apical dominance promotes the growth of lateral buds.
 Choose the option with all correct statements.
 (1) A, C, E only (2) A, D, E only
 (3) B, D, E only (4) A, B, C only

- 113 Which of the following type of immunity is present at the time of birth and is a non-specific type of defence in the human body?
 (1) Innate Immunity
 (2) Cell-mediated Immunity
 (3) Humoral Immunity
 (4) Acquired Immunity

- 114 Why can't insulin be given orally to diabetic patients?
 (1) It will be digested in Gastro-Intestinal (GI) tract
 (2) Because of structural variation
 (3) Its bioavailability will be increased
 (4) Human body will elicit strong immune response

- 115 Which one of the following equations represents the Verhulst-Pearl Logistic Growth of population?
 (1) $\frac{dN}{dt} = rN \left(\frac{K-N}{K} \right)$
 (2) $\frac{dN}{dt} = rN \left(\frac{N-K}{N} \right)$
 (3) $\frac{dN}{dt} = N \left(\frac{r-K}{K} \right)$
 (4) $\frac{dN}{dt} = r \left(\frac{K-N}{K} \right)$

116 Silencing of specific mRNA is possible via RNAi because of -

- (1) Inhibitory ssRNA
- (2) Complementary tRNA
- (3) Non-complementary ssRNA
- (4) Complementary dsRNA

117 Match List I with List II.

List I

- A. Adenosine
- B. Adenylic acid
- C. Adenine
- D. Alanine

List II

- I. Nitrogen base
- II. Nucleotide
- III. Nucleoside
- IV. Amino acid

Choose the option with all correct matches.

- (1) A-III, B-II, C-IV, D-I
- (2) A-III, B-II, C-I, D-IV
- (3) A-II, B-III, C-I, D-IV
- (4) A-III, B-IV, C-II, D-I

118 Frogs respire in water by skin and buccal cavity and on land by skin, buccal cavity and lungs.

Choose the correct answer from the following :

- (1) The statement is true for both the environment
- (2) The statement is false for water but true for land
- (3) The statement is false for both the environment
- (4) The statement is true for water but false for land

119 All living members of the class Cyclostomata are:

- (1) Endoparasite
- (2) Symbiotic
- (3) Ectoparasite
- (4) Free living

120 Identify the statement that is NOT correct.

- (1) The heavy and light chains are held together by disulfide bonds.
- (2) Antigen binding site is located at C-terminal region of antibody molecules.
- (3) Constant region of heavy and light chains are located at C-terminus of antibody molecules.
- (4) Each antibody has two light and two heavy chains.

121 Given below are two statements : one is labelled as Assertion (A) and the other is labelled as Reason (R).

Assertion (A) : The primary function of the Golgi apparatus is to package the materials made by the endoplasmic reticulum and deliver it to intracellular targets and outside the cell.

Reason (R) : Vesicles containing materials made by the endoplasmic reticulum fuse with the cis face of the Golgi apparatus, and they are modified and released from the trans face of the Golgi apparatus.

In the light of the above statements, choose the correct answer from the options given below:

- (1) Both A and R are true but R is not the correct explanation of A
- (2) A is true but R is false
- (3) A is false but R is true
- (4) Both A and R are true and R is the correct explanation of A

122 Consider the following :

- A. The reductive division for the human female gametogenesis starts earlier than that of the male gametogenesis.
- B. The gap between the first meiotic division and the second meiotic division is much shorter for males compared to females.
- C. The first polar body is associated with the formation of the primary oocyte.
- D. Luteinizing Hormone (LH) surge leads to disintegration of the endometrium and onset of menstrual bleeding.

Choose the **correct** answer from the options given below :

- (1) A and C are true
- (2) B and D are true
- (3) B and C are true
- (4) A and B are true

123 Match List I with List II :

List I	List II
A. Scutellum	I. Persistent nucellus
B. Non-albuminous seed	II. Cotyledon of Monocot seed
C. Epiblast	III. Groundnut
D. Perisperm	IV. Rudimentary cotyledon

Choose the option with all **correct** matches.

- (1) A-IV, B-III, C-II, D-I
- (2) A-IV, B-III, C-I, D-II
- (3) A-II, B-IV, C-III, D-I
- (4) A-II, B-III, C-IV, D-I

124 What is the main function of the spindle fibers during mitosis ?

- (1) To synthesize new DNA
- (2) To repair damaged DNA
- (3) To regulate cell growth
- (4) To separate the chromosomes

125 Which of the following statements about RuBisCO is true?

- (1) It has higher affinity for oxygen than carbon dioxide.
- (2) It is an enzyme involved in the photolysis of water.
- (3) It catalyzes the carboxylation of RuBP.
- (4) It is active only in the dark.

126 Given below are two statements :

Statement I : The DNA fragments extracted from gel electrophoresis can be used in construction of recombinant DNA.

Statement II : Smaller size DNA fragments are observed near anode while larger fragments are found near the wells in an agarose gel.

In the light of the above statements, choose the **most appropriate** answer from the options given below :

- (1) Both statement I and statement II are incorrect
- (2) Statement I is correct but statement II is incorrect
- (3) Statement I is incorrect but statement II is correct
- (4) Both statement I and statement II are correct

127 Which factor is important for termination of transcription?

- (1) σ (sigma)
- (2) ρ (rho)
- (3) γ (gamma)
- (4) α (alpha)

128 Consider the following statements regarding function of adrenal medullary hormones :

- A. It causes pupillary constriction
- B. It is a hyperglycemic hormone
- C. It causes piloerection
- D. It increases strength of heart contraction

Choose the **correct** answer from the options given below :

- (1) B, C and D Only
- (2) A, C and D Only
- (3) D Only
- (4) C and D Only

- 129 Histones are enriched with -
- (1) Leucine & Lysine
 - (2) Phenylalanine & Leucine
 - (3) Phenylalanine & Arginine
 - (4) Lysine & Arginine
- 130 Genes R and Y follow independent assortment. If RRYy produce round yellow seeds and rryy produce wrinkled green seeds, what will be the phenotypic ratio of the F₂ generation?
- (1) Phenotypic ratio - 3 : 1
 - (2) Phenotypic ratio - 9 : 3 : 3 : 1
 - (3) Phenotypic ratio - 9 : 7
 - (4) Phenotypic ratio - 1 : 2 : 1
- 131 Which of the following hormones released from the pituitary is actually synthesized in the hypothalamus ?
- (1) Anti-diuretic hormone (ADH)
 - (2) Follicle-stimulating hormone (FSH)
 - (3) Adenocorticotrophic hormone (ACTH)
 - (4) Luteinizing hormone (LH)
- 132 Given below are two statements : one is labelled as **Assertion (A)** and the other is labelled as **Reason (R)**.
- Assertion (A) :** All vertebrates are chordates but all chordates are not vertebrate.
- Reason (R) :** The members of subphylum vertebrata possess notochord during the embryonic period, the notochord is replaced by a cartilaginous or bony vertebral column in adults.
- In the light of the above statements, choose the **correct** answer from the options given below:
- (1) Both **A** and **R** are true but **R** is **not** the correct explanation of **A**
 - (2) **A** is true but **R** is false
 - (3) **A** is false but **R** is true
 - (4) Both **A** and **R** are true and **R** is the correct explanation of **A**

- 133 Given below are two statements :
- Statement I :** Fig fruit is a non-vegetarian fruit as it has enclosed fig wasps in it.
- Statement II :** Fig wasp and fig tree exhibit mutual relationship as fig wasp completes its life cycle in fig fruit and fig fruit gets pollinated by fig wasp.
- In the light of the above statements, choose the **most appropriate** answer from the options given below :
- (1) Both statement I and statement II are incorrect
 - (2) Statement I is correct but statement II is incorrect
 - (3) Statement I is incorrect but statement II is correct
 - (4) Both statement I and statement II are correct
- 134 Sweet potato and potato represent a certain type of evolution. Select the correct combination of terms to explain the evolution.
- (1) Homology, divergent
 - (2) Homology, convergent
 - (3) Analogy, divergent
 - (4) Analogy, convergent
- 135 Which of the following microbes is **NOT** involved in the preparation of household products?
- A. *Aspergillus niger*
 - B. *Lactobacillus*
 - C. *Trichoderma polysporum*
 - D. *Saccharomyces cerevisiae*
 - E. *Propionibacterium sharmanii*
- Choose the **correct** answer from the options given below:
- (1) A and C only
 - (2) C and D only
 - (3) C and E only
 - (4) A and B only

- 136 Identify the part of a bio-reactor which is used as a foam breaker from the given figure.

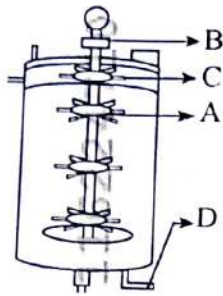

- (1) B (2) D
(3) C (4) A

- 137 Name the class of enzyme that usually catalyze the following reaction :



Where, G → a group other than hydrogen

S → a substrate

S[#] → another substrate

- (1) Lyase (2) Transferase
(3) Ligase (4) Hydrolase

- 138 Match List I with List II :

List I	List II
A. Chlorophyll a	I. Yellow-green
B. Chlorophyll b	II. Yellow
C. Xanthophylls	III. Blue-green
D. Carotenoids	IV. Yellow to Yellow-orange

Choose the option with all correct matches.

- (1) A-III, B-I, C-II, D-IV
(2) A-I, B-II, C-IV, D-III
(3) A-I, B-IV, C-III, D-II
(4) A-III, B-IV, C-II, D-I

- 139 The correct sequence of events in the life cycle of bryophytes is
- Fusion of antherozoid with egg.
 - Attachment of gametophyte to substratum.
 - Reduction division to produce haploid spores.
 - Formation of sporophyte.
 - Release of antherozoids into water.

Choose the correct answer from the options given below :

- (1) B, E, A, C, D (2) B, E, A, D, C
(3) D, E, A, B, C (4) D, E, A, C, B

- 140 Match List - I with List - II.

List - I	List - II
A. Centromere	I. Mitochondrion
B. Cilium	II. Cell division
C. Cristae	III. Cell movement
D. Cell membrane	IV. Phospholipid Bilayer

Choose the correct answer from the options given below :

- (1) A-II, B-I, C-IV, D-III
(2) A-IV, B-II, C-III, D-I
(3) A-II, B-III, C-I, D-IV
(4) A-I, B-II, C-III, D-IV

- 141 Find the correct statements :

- In human pregnancy, the major organ systems are formed at the end of 12 weeks.
- In human pregnancy the major organ systems are formed at the end of 8 weeks.
- In human pregnancy heart is formed after one month of gestation.
- In human pregnancy, limbs and digits develop by the end of second month.
- In human pregnancy the appearance of hair is usually observed in the fifth month.

Choose the correct answer from the options given below :

- (1) B and C Only
(2) B, C, D and E Only
(3) A, C, D and E Only
(4) A and E Only

142 Each of the following characteristics represent a Kingdom proposed by Whittaker. Arrange the following in increasing order of complexity of body organization.

- A. Multicellular heterotrophs with cell wall made of chitin.
- B. Heterotrophs with tissue/organ/organ system level of body organization.
- C. Prokaryotes with cell wall made of polysaccharides and amino acids.
- D. Eukaryotic autotrophs with tissue/organ level of body organization.
- E. Eukaryotes with cellular body organization.

Choose the **correct** answer from the options given below :

- (1) C, E, A, D, B (2) A, C, E, D, B
(3) C, E, A, B, D (4) A, C, E, B, D

143 Which are correct:

- A. Computed tomography and magnetic resonance imaging detect cancers of internal organs.
- B. Chemotherapeutic drugs are used to kill non-cancerous cells.
- C. α -interferon activate the cancer patients' immune system and helps in destroying the tumour.
- D. Chemotherapeutic drugs are biological response modifiers.
- E. In the case of leukaemia blood cell counts are decreased.

Choose the **correct** answer from the options given below:

- (1) D and E only (2) C and D only
(3) A and C only (4) B and D only

144 Which of the following genetically engineered organisms was used by Eli Lilly to prepare human insulin?

- (1) Yeast (2) Virus
(3) Phage (4) Bacterium

145 What is the pattern of inheritance for polygenic trait?

- (1) Non-mendelian inheritance pattern
- (2) Autosomal dominant pattern
- (3) X-linked recessive inheritance pattern
- (4) Mendelian inheritance pattern

146 Which of the following are the post-transcriptional events in an eukaryotic cell?

- A. Transport of pre-mRNA to cytoplasm prior to splicing.
- B. Removal of introns and joining of exons.
- C. Addition of methyl group at 5' end of hnRNA.
- D. Addition of adenine residues at 3' end of hnRNA.
- E. Base pairing of two complementary RNAs.

Choose the **correct** answer from the options given below :

- (1) B, C, D only (2) B, C, E only
(3) C, D, E only (4) A, B, C only

147 Which one of the following phytohormones promotes nutrient mobilization which helps in the delay of leaf senescence in plants?

- (1) Abscisic acid (2) Gibberellin
(3) Cytokinin (4) Ethylene

148 Which one of the following statements refers to Reductionist Biology?

- (1) Physiological approach to study and understand living organisms.
- (2) Chemical approach to study and understand living organisms.
- (3) Behavioural approach to study and understand living organisms.
- (4) Physico-chemical approach to study and understand living organisms.

149 Match List - I with List - II.

List - I

List - II

- | | |
|-----------------------|--|
| A. Emphysema | I. Rapid spasms in muscle due to low Ca^{++} in body fluid |
| B. Angina Pectoris | II. Damaged alveolar walls and decreased respiratory surface |
| C. Glomerulonephritis | III. Acute chest pain when not enough oxygen is reaching to heart muscle |
| D. Tetany | IV. Inflammation of glomeruli of kidney |

Choose the correct answer from the options given below :

- (1) A-II, B-I, C-II, D-IV
- (2) A-II, B-IV, C-III, D-I
- (3) A-II, B-III, C-IV, D-I
- (4) A-III, B-I, C-IV, D-II

150 Epiphytes that are growing on a mango branch is an example of which of the following?

- (1) Mutualism
- (2) Predation
- (3) Amensalism
- (4) Commensalism

151 Match List I with List II :

List-I

List-II

- | | |
|------------------------------------|---------------------------------------|
| A. Alfred Hershey and Martha Chase | I. Streptococcus pneumoniae |
| B. Euchromatin | II. Densely packed and dark-stained |
| C. Frederick Griffith | III. Loosely packed and light-stained |
| D. Heterochromatin | IV. DNA as genetic material |

Choose the correct answer from the options given below :

- (1) A-IV, B-II, C-I, D-III
- (2) A-IV, B-III, C-I, D-II
- (3) A-III, B-II, C-IV, D-I
- (4) A-II, B-IV, C-I, D-III

46_English I

152

Which chromosome in the human genome has the highest number of genes?

- (1) Chromosome Y
- (2) Chromosome 1
- (3) Chromosome 10
- (4) Chromosome X

153

What are the potential drawbacks in adoption of the IVF method?

- A. High fatality risk to mother
- B. Expensive instruments and reagents
- C. Husband/wife necessary for being donors
- D. Less adoption of orphans
- E. Not available in India
- F. Possibility that the early embryo does not survive

Choose the correct answer from the options given below :

- (1) A, C, D, E only
- (2) A, B, C, D only
- (3) A, B, C, E, F only
- (4) B, D, F only

154 Match List - I with List - II.

List - I

List - II

- | | |
|-----------------|----------------------|
| A. Head | I. Enzymes |
| B. Middle piece | II. Sperm motility |
| C. Acrosome | III. Energy |
| D. Tail | IV. Genetic material |

Choose the correct answer from the options given below :

- (1) A-IV, B-III, C-II, D-I
- (2) A-III, B-IV, C-II, D-I
- (3) A-III, B-II, C-I, D-IV
- (4) A-IV, B-III, C-I, D-II

155 From the statements given below choose the correct option :

- A. The eukaryotic ribosomes are 80S and prokaryotic ribosomes are 70S.
- B. Each ribosome has two sub-units.
- C. The two sub-units of 80S ribosome are 60S and 40S while that of 70S are 50S and 30S.
- D. The two sub-units of 80S ribosome are 60S and 20S and that of 70S are 50S and 20S.
- E. The two sub-units of 80S are 60S and 30S and that of 70S are 50S and 30S.

- (1) A, B, D are true
- (2) A, B, E are true
- (3) B, D, E are true
- (4) A, B, C are true

156 Which of the following is an example of non-distilled alcoholic beverage produced by yeast?

- (1) Brandy
- (2) Beer
- (3) Rum
- (4) Whisky

157 Who is known as the father of Ecology in India?

- (1) Ramdeo Misra
- (2) Ram Udar
- (3) Birbal Sahni
- (4) S. R. Kashyap

158 In the seeds of cereals, the outer covering of endosperm separates the embryo by a protein-rich layer called :

- (1) Coleorhiza
- (2) Integument
- (3) Aleurone layer
- (4) Coleoptile

159 Which of the following statement is correct about location of the male frog copulatory pad?

- (1) First digit of hind limb
- (2) Second digit of fore limb
- (3) First digit of the fore limb
- (4) First and Second digit of fore limb

160 A specialised membranous structure in a prokaryotic cell which helps in cell wall formation, DNA replication and respiration is:

- (1) Chromatophores
- (2) Cristae
- (3) Endoplasmic Reticulum
- (4) Mesosome

161 Given below are two statements :

Statement I : Transfer RNAs and ribosomal RNA do not interact with mRNA.

Statement II : RNA interference (RNAi) takes place in all eukaryotic organisms as a method of cellular defence.

In the light of the above statements, choose the most appropriate answer from the options given below :

- (1) Both Statement I and Statement II are incorrect
- (2) Statement I is correct but Statement II is incorrect
- (3) Statement I is incorrect but Statement II is correct
- (4) Both Statement I and Statement II are correct

162 What is the name of the blood vessel that carries deoxygenated blood from the body to the heart in a frog ?

- (1) Pulmonary artery
- (2) Pulmonary vein
- (3) Vena cava
- (4) Aorta

163 Given below are two statements :

Statement I : In the RNA world, RNA is considered the first genetic material evolved to carry out essential life processes. RNA acts as a genetic material and also as a catalyst for some important biochemical reactions in living systems. Being reactive, RNA is unstable.

Statement II : DNA evolved from RNA and is a more stable genetic material. Its double helical strands being complementary, resist changes by evolving repairing mechanism.

In the light of the above statements, choose the **most appropriate** answer from the options given below :

- (1) Both statement I and statement II are incorrect
- (2) Statement I is correct but statement II is incorrect
- (3) Statement I is incorrect but statement II is correct
- (4) Both statement I and statement II are correct

164 Which one of the following is an example of ex-situ conservation?

- (1) Wildlife Sanctuary
- (2) Zoos and botanical gardens
- (3) Protected areas
- (4) National Park

165 Which one of the following enzymes contains 'Haem' as the prosthetic group?

- (1) Carbonic anhydrase
- (2) Succinate dehydrogenase
- (3) Catalase
- (4) RuBisCo

166 Given below are the stages in the life cycle of pteridophytes. Arrange the following stages in the correct sequence.

- A. Prothallus stage
- B. Meiosis in spore mother cells
- C. Fertilisation
- D. Formation of archegonia and antheridia in gametophyte.
- E. Transfer of antherozoids to the archegonia in presence of water.

Choose the **correct** answer from the options given below :

- (1) B, A, E, C, D
- (2) D, E, C, A, B
- (3) E, D, C, B, A
- (4) B, A, D, E, C

167 Which of following organisms *cannot* fix nitrogen?

- A. *Azotobacter*
- B. *Oscillatoria*
- C. *Anabaena*
- D. *Volvox*
- E. *Nostoc*

Choose the **correct** answer from the options given below:

- (1) D only
- (2) B only
- (3) E only
- (4) A only

168 While trying to find out the characteristic of a newly found animal, a researcher did the histology of adult animal and observed a cavity with presence of mesodermal tissue towards the body wall but no mesodermal tissue was observed towards the alimentary canal. What could be the possible coelome of that animal?

- (1) Pseudocoelomate
- (2) Schizocoelomate
- (3) Spongocoelomate
- (4) Acoelomate

169 Given below are two statements :

Statement I : In a floral formula \oplus stands for zygomorphic nature of the flower, and \underline{G} stands for inferior ovary.

Statement II : In a floral formula \oplus stands for actinomorphic nature of the flower and \underline{G} stands for superior ovary.

In the light of the above statements, choose the correct answer from the options given below:

- (1) Both Statement I and Statement II are incorrect
- (2) Statement I is correct but Statement II is incorrect
- (3) Statement I is incorrect but Statement II is correct
- (4) Both Statement I and Statement II are correct

170 Given below are two statements :

Statement I : The primary source of energy in an ecosystem is solar energy.

Statement II : The rate of production of organic matter during photosynthesis in an ecosystem is called net primary productivity (NPP).

In the light of the above statements, choose the most appropriate answer from the options given below :

- (1) Both statement I and statement II are incorrect
- (2) Statement I is correct but statement II is incorrect
- (3) Statement I is incorrect but statement II is correct
- (4) Both statement I and statement II are correct

171 Which of the following diagrams is correct with regard to the proximal (P) and distal (D) tubule of the Nephron.

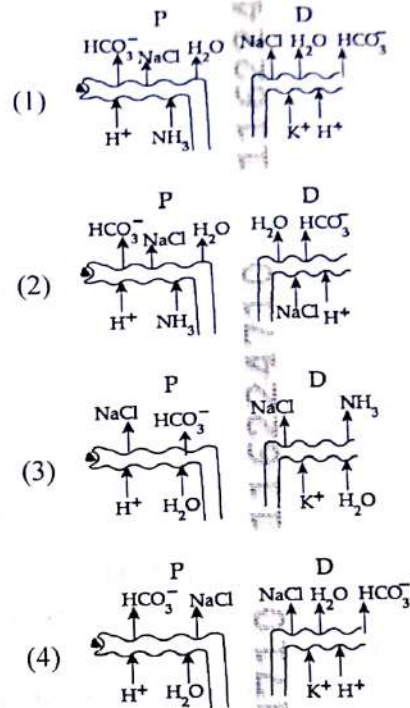

172 Streptokinase produced by bacterium *Streptococcus* is used for

- (1) Ethanol production
- (2) Liver disease treatment
- (3) Removing clots from blood vessels
- (4) Curd production

173 Cardiac activities of the heart are regulated by:

- A. Nodal tissue
- B. A special neural centre in the medulla oblongata
- C. Adrenal medullary hormones
- D. Adrenal cortical hormones

Choose the correct answer from the options given below :

- (1) A, B, C and D
- (2) A, C and D Only
- (3) A, B and D Only
- (4) A, B and C Only

174 Given below are two statements : One is labelled as **Assertion (A)** and the other is labelled as **Reason (R)**.

Assertion (A) : A typical unfertilised, angiosperm embryo sac at maturity is 8 nucleate and 7-celled.

Reason (R) : The egg apparatus has 2 polar nuclei.

In the light of the above statements, choose the correct answer from the options given below:

- (1) Both **A** and **R** are true but **R** is **NOT** the correct explanation of **A**
- (2) **A** is true but **R** is false
- (3) **A** is false but **R** is true
- (4) Both **A** and **R** are true and **R** is the correct explanation of **A**

175 Find the statement that is **NOT** correct with regard to the structure of monocot stem.

- (1) Vascular bundles are scattered.
- (2) Vascular bundles are conjoint and closed.
- (3) Phloem parenchyma is absent.
- (4) Hypodermis is parenchymatous.

176 Given below are two statements : One is labelled as **Assertion (A)** and the other is labelled as **Reason (R)**.

Assertion (A) : Both wind and water pollinated flowers are not very colourful and do not produce nectar.

Reason (R) : The flowers produce enormous amount of pollen grains in wind and water pollinated flowers.

In the light of the above statements, choose the correct answer from the options given below:

- (1) Both **A** and **R** are true but **R** is **NOT** the correct explanation of **A**
- (2) **A** is true but **R** is false
- (3) **A** is false but **R** is true
- (4) Both **A** and **R** are true and **R** is the correct explanation of **A**

177 Neoplastic characteristics of cells refer to :

- A. A mass of proliferating cell
- B. Rapid growth of cells
- C. Invasion and damage to the surrounding tissue
- D. Those confined to original location

Choose the **correct** answer from the options given below:

- (1) A, B, C only
- (2) A, B, D only
- (3) B, C, D only
- (4) A, B only

178 The complex II of mitochondrial electron transport chain is also known as

- (1) Succinate dehydrogenase
- (2) Cytochrome c oxidase
- (3) NADH dehydrogenase
- (4) Cytochrome bc_1

179 Polymerase chain reaction (PCR) amplifies DNA following the equation.

- (1) 2^n
- (2) $2n + 1$
- (3) $2N^2$
- (4) N^2

180

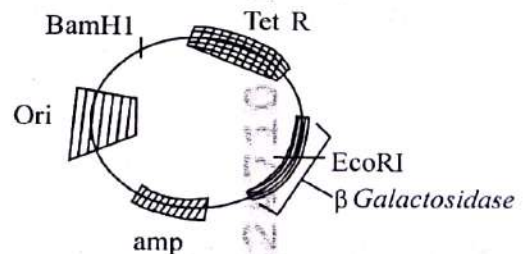

In the above represented plasmid an alien piece of DNA is inserted at EcoRI site. Which of the following strategies will be chosen to select the recombinant colonies?

- (1) Blue color colonies will be selected.
- (2) White color colonies will be selected.
- (3) Blue color colonies grown on ampicillin plates can be selected.
- (4) Using ampicillin & tetracyclin containing medium plate.