

## RBI Grade B Memory Based Paper 2024

**Directions (1-9): Read the following passage to answer the given question.**

The ongoing intellectual property (IP) dispute between the United States and Myanmar has drawn attention, particularly concerning trademark laws and patent rights. Myanmar's decision to step back from international IP agreements and build its own patent system has raised concerns in the U.S., which stresses the importance of aligning with global standards for intellectual property protection.

The U.S. has voiced its apprehension over Myanmar's withdrawal from established IP frameworks, particularly those that support trademarks and patents. Intellectual property rights play a crucial role in global trade and innovation. Adhering to international IP agreements is essential for countries involved in global commerce, as it ensures the protection of businesses and inventors. The U.S. maintains that Myanmar's move could disrupt trade relations, complicate the protection of American business interests, and create a less favorable environment for foreign investment.

Myanmar's decision to create its own patent system, rather than adhering fully to global agreements like the World Intellectual Property Organization (WIPO), is a key point of contention. While national patent systems are common, the U.S. is concerned that Myanmar's system might not meet international standards. This inconsistency could create barriers for U.S. businesses seeking to protect their IP in Myanmar, leading to higher costs and potential legal disputes. Furthermore, a weak IP system in Myanmar could encourage counterfeiting and undermine the protections that American companies rely on globally.

A significant legal framework relevant to this dispute is Section 103 of The Trade Marks Act, 1999, which governs trademark protection in many countries adhering to international standards. Section 103 addresses trademark infringement, registration, and penalties for violations. It offers legal remedies like injunctions, damages, and the seizure of infringing goods, thus safeguarding the rights of trademark owners. The U.S. is concerned that Myanmar's actions may dilute protections provided under frameworks like Section 103, affecting the ability of U.S. companies to safeguard their trademarks in the country.

American businesses depend on legal protections such as those outlined in Section 103 to ensure their IP is respected abroad. If Myanmar's patent system fails to offer the same level of protection, U.S. companies could face challenges, including legal battles and financial losses. Moreover, insufficient IP protection may lead to an increase in counterfeit goods, harming both businesses and consumers.

The U.S. also emphasizes that Myanmar's participation in global IP agreements is critical to its economic development. \_\_\_\_\_ . By stepping away from international agreements and establishing its own patent framework, Myanmar risks losing investor confidence and limiting its economic growth.

In conclusion, the ongoing intellectual property dispute between the United States and Myanmar highlights the complexities of international trade and the importance of intellectual property protections in fostering economic growth and innovation. The concerns raised by the U.S. regarding Myanmar's decision to establish its own patent system and the potential implications for trademark protection under frameworks like Section 103 of The Trade Marks Act, 1999, underscore the need for collaboration and alignment with global IP standards.

---

Adda247

# Test Prime

**ALL EXAMS, ONE SUBSCRIPTION**



**1,00,000+**  
Mock Tests



**Personalised  
Report Card**



**Unlimited  
Re-Attempt**



**600+**  
Exam Covered



**25,000+** Previous  
Year Papers



**500%**  
Refund



**ATTEMPT FREE MOCK NOW**

**Q1.** What is the primary concern of the United States regarding Myanmar's decision to create its own patent system?

- (a) The U.S. is concerned that Myanmar's patent system will result in increased taxes for American companies, making it harder for them to conduct business in the country.
- (b) The U.S. believes that it may lead to higher operational costs for U.S. businesses, as they will need to comply with different and potentially less reliable IP protection standards.
- (c) The U.S. government fears that it will make it easier for U.S. companies to register their intellectual property without facing international scrutiny, which may reduce transparency.
- (d) Myanmar's decision could increase the likelihood of innovative goods in the market, harming American businesses and consumers globally.
- (e) The U.S. is concerned that Myanmar's new patent system could limit foreign investments, as it may not offer the same legal protections provided by international IP agreements.

**Q2.** How does the United States view the role of international intellectual property (IP) agreements in global trade?

- (a) The U.S. sees international IP agreements as useful but believes that countries like Myanmar should have the freedom to adapt them to their national interests without significant consequences for global trade.
- (b) The U.S. views international IP agreements as a barrier to innovation, which reduces the ability of countries to create independent IP systems.
- (c) The U.S. believes that they are essential for ensuring the protection of businesses and inventors involved in global commerce, thereby safeguarding trade relations and foreign investments.
- (d) The U.S. argues that international IP agreements are primarily designed to protect developing nations' intellectual property.
- (e) The U.S. maintains that international IP agreements are important, and they should be applied when the majority of trading partners agree to adopt them simultaneously to avoid competitive disadvantages.

**Q3.** Why does the U.S. highlight Section 103 of The Trade Marks Act, 1999, in the context of the dispute with Myanmar?

- (a) The U.S. wants to promote Section 103 globally to ensure that all countries follow the same standards for trademark and patent protection.
  - (b) The U.S. believes that Section 103 offers superior protection for U.S. businesses and should be adopted by Myanmar as part of its national patent system to avoid legal conflicts.
  - (c) The U.S. emphasizes Section 103 because it provides legal remedies such as injunctions, damages, and the seizure of infringing goods, which could help American businesses to perpetuate in the longer run.
  - (d) The U.S. is concerned that Myanmar's actions may dilute protections provided by frameworks like Section 103, making it harder for U.S. companies to safeguard their trademarks in the country.
  - (e) The U.S. is concerned that Section 103 gives too much power to foreign businesses, undermining the
-

**Q4. What is one potential risk highlighted in the passage if Myanmar's intellectual property protection system does not meet international standards?**

- (a) U.S. businesses may benefit from reduced competition in Myanmar's market due to less stringent IP regulations, allowing them to operate with fewer legal restrictions and challenges from local competitors.
- (b) Insufficient protection under Myanmar's IP system could result in an influx of counterfeit goods, negatively affecting not only U.S. businesses through financial losses but also harming consumers by reducing the quality and reliability of available products.
- (c) The lack of alignment with global IP standards may give U.S. companies an opportunity to evade international scrutiny, allowing them to operate with more flexibility in protecting their intellectual property.
- (d) Myanmar's patent system could encourage greater investment in the country by lowering the costs associated with intellectual property registration and litigation, making it easier for U.S. businesses to enter the market.
- (e) A weaker IP system in Myanmar could allow U.S. businesses to dominate the market, as fewer foreign companies will be interested in investing in a country with unreliable intellectual property protection laws.

**Q5. What are the possible aftermaths of Myanmar's withdrawal from established IP frameworks, as mentioned in the passage?**

- (I) U.S. businesses may encounter legal challenges and financial setbacks due to insufficient intellectual property protection.
  - (II) The prevalence of counterfeit products could rise, negatively impacting both businesses and consumers.
  - (III) Myanmar's withdrawal might lead to improved trade relations with the U.S. by fostering a more independent national IP system.
- (a) Only (I)
  - (b) Only (II)
  - (c) Both (I) and (II)
  - (d) Both (I) and (III)
  - (e) All (I), (II), and (III)

**Q6. Which of the following sentence should be used to fill the given blank?**

- (a) A strong IP system attracts foreign investment by securing innovations.
- (b) Myanmar's independent IP system will promote greater innovation within the country.
- (c) Investor confidence is rarely influenced by intellectual property protections.
- (d) Foreign companies are more likely to invest in countries with weak IP protections.
- (e) Participation in international agreements ensures Myanmar's IP system aligns with global standards.

**Q7. According to the passage, how might a weak intellectual property system in Myanmar affect U.S. companies?**

- (a) U.S. companies may need to collaborate with Myanmar's government to co-develop stronger IP protections.
  - (b) U.S. companies may benefit from reduced legal regulations, making it easier to operate in Myanmar.
  - (c) U.S. businesses may face difficulties from a surge in counterfeit products, leading to monetary losses and a decline in brand credibility.
  - (d) U.S. companies may enjoy greater freedom in Myanmar due to weaker IP enforcement, allowing them to bypass international restrictions.
  - (e) U.S. companies may face stricter legal penalties for failing to comply with Myanmar's new IP system.
-

**Q8. Which of the following conclusions can be logically inferred from the above statements?**

- (a) Myanmar's independent patent system will prevent foreign companies from facing legal challenges.
- (b) Establishing a unique patent system may lead to more complex legal disputes for foreign businesses.
- (c) Countries with strong IP protection experience higher levels of IP violations.
- (d) A strong IP protection system has no impact on a country's economic losses from intellectual property violations.
- (e) Foreign businesses will prefer to invest in countries with weaker IP protection systems.

**Q9. Based on the information provided in the passage, which of the following would most likely occur if Myanmar continues to deviate from international IP agreements and implements its own independent patent system?**

- (a) Myanmar will see an increase in foreign investments due to its unique IP framework.
- (b) U.S. companies may find it easier to protect their intellectual property in Myanmar.
- (c) Myanmar's move could encourage other countries to follow suit and establish their own patent systems.
- (d) Foreign companies may face difficulties in protecting their trademarks and patents in Myanmar, potentially leading to economic and legal disputes.
- (e) Counterfeit goods will decline as Myanmar establishes its independent patent system.

Directions (10-11): **Rearrange the following five sentences (A), (B), (C) and (D) in the proper sequence to form a meaningful paragraph and then answer the question given below.**

**Q10.** (A) The scheme is designed to offer a balanced solution, ensuring both retirees' financial security and the government's fiscal responsibility.

(B) The Unified Pension Scheme seeks to merge different pension systems into a single, streamlined structure.

(C) This approach addresses employees' demands for higher pensions while safeguarding the government's capacity to finance the program.

(D) Additionally, the unified structure aims to lower administrative expenses and promote a more equitable distribution of pension benefits.

- (a) CDBA
- (b) BACD
- (c) BDAC
- (d) CBDA
- (e) BADC

**Q11.** (A) Hydropower projects are often promoted as a renewable energy source that can help meet the growing demand for electricity.

(B) However, these projects can have significant environmental impacts, such as altering river ecosystems and displacing communities.

(C) Striking a balance between energy generation and environmental protection is crucial to ensure sustainable development.

(D) The challenge lies in developing hydropower responsibly, while minimizing harm to ecosystems and local populations.

- (a) CDBA
  - (b) ABCD
  - (c) ABDC
  - (d) CBDA
  - (e) ACDB
-

**Directions (12-14):** In the provided questions, an idiom is presented, followed by three statements. Identify the statements that correctly use the given idiom.

**Q12. Taken aback**

- (A) She was taken aback by the sudden news of her promotion and couldn't believe it.  
(B) He took a step back and was taken aback to get a better view of the painting.  
(C) They were taken aback by the strong wind as they walked along the beach.  
(a) Both A & C  
(b) Only A  
(c) Both B & C  
(d) Only C  
(e) All A, B, C

**Q13. Back in the saddle**

- (A) After recovering from her injury, the sportswoman was back in the saddle, training harder than ever.  
(B) After the meeting, she was back in the saddle, enjoying her vacation by the beach.  
(C) After taking a long break, she decided to get back in the saddle and start painting again.  
(a) Both A & B  
(b) Only C  
(c) Both A & C  
(d) Only B  
(e) All A, B, C

**Q14. Keep the ball rolling**

- (A) Despite the setback, the leader motivated everyone to keep the ball rolling and not lose focus on the final goal.  
(B) After gaining the initial investment, the entrepreneur worked hard to keep the ball rolling by seeking more funding.  
(C) The coach told the team to keep the ball rolling after they scored the first goal to secure the win.  
(a) Only A  
(b) Both A & B  
(c) Both B & C  
(d) All A, B, C  
(e) Only C

**Directions (15-17):** In each of the questions given below few words are given in bold. These words may or may not be in their correct position. The sentence is then followed by options with the correct combination of words that should replace each other in order to make the sentence grammatically and contextually correct. Find the correct combination of the words that should be interchanged.

**Q15.** Sampoonata Abhiyan is an initiative **empowerment (A)** at promoting **education (B)** development and **aimed (C)** through **holistic (D)**, skill-building, and community welfare programs, **particularly (E)** in underprivileged areas.

- (a) A-E  
(b) A-E & B-C  
(c) B-C  
(d) A-C & B-D  
(e) No interchange required
-

**Q16.** The National Financial Reporting Authority ensures the **quality (A)** of financial **regulating (B)** by **reporting (C)** and overseeing audit practices, **financial (D)** transparency and accountability in **promoting (E)** statements.

- (a) B-C & D-E
- (b) A-C
- (c) D-E
- (d) B-D & C-E
- (e) No interchange required

**Q17.** Tarang Shakti-2024 **challenges (A)** on improving strategic **defense (B)** capabilities and fostering collaboration between **address (C)** forces to **armed (D)** evolving security **focuses (E)**.

- (a) B-D and A-C
- (b) A-D
- (c) A-E
- (d) A-E & C-D
- (e) No interchange required

**Directions (18-19):** In the following question, identify the statement which is grammatically and contextually correct.

**Q18.**

- (i) The books on the shelves in the library are organized by genre, making them easier to locate.
  - (ii) The proposal was submitted by email to the supervisor, who reviewed it carefully before giving feedback.
  - (iii) Hardly the meeting had begun when the fire alarm sounded, causing everyone to evacuate the building.
- (a) only (i)
  - (b) Both (i) and (ii)
  - (c) Only (ii)
  - (d) Both (ii) and (iii)
  - (e) All are correct

**Q19.**

- (i) She is working tirelessly though the night to finish the project by the deadline on Friday.
  - (ii) Seldom have we witnessed such an incredible performance, captivating the audience from beginning to end.
  - (iii) The list of items for the event, including decorations and food, has been finalized by the team.
- (a) only (i)
  - (b) Both (i) and (ii)
  - (c) Only (iii)
  - (d) Both (ii) and (iii)
  - (e) All are correct
-

**Directions (20-21):** In the following questions, identify the statement that is grammatically incorrect.

**Q20.**

- (i) Each of the participants brought his/her own materials, ensuring that the workshop ran smoothly and without interruptions.
  - (ii) Neither of the candidates have revealed his/her full agenda, but both promise significant reforms if elected.
  - (iii) Either the teacher or the students is responsible for ensuring the room is left clean after class.
- (a) only (i)
  - (b) Both (i) and (ii)
  - (c) Only (iii)
  - (d) Both (ii) and (iii)
  - (e) All are incorrect

**Q21.**

- (a) Not only the team completed the task ahead of time, but they also exceeded expectations.
  - (b) The quality of the products and the level of customer service have greatly improved since the new management.
  - (c) Anybody who wants to participate must submit his/her application by Friday, as late entries will not be accepted.
- (a) only (i)
  - (b) Both (i) and (ii)
  - (c) Only (iii)
  - (d) Both (ii) and (iii)
  - (e) All are incorrect

**Directions (22-24):** In the following question, two sentence are provided. Choose the most suitable connector to adjoin the sentences to form a grammatically and contextually correct sentence.

**Q22.**

- (A) There are numerous challenges, including budget constraints, tight deadlines, and unexpected technical difficulties.
  - (B) the project team managed to deliver an innovative solution that exceeded the client's expectations.
- (i) Despite facing numerous challenges
  - (ii) Given that the project team
  - (iii) Even if the challenges
- (a) Only (i)
  - (b) Only (ii)
  - (c) Both (i) and (ii)
  - (d) Both (ii) and (iii)
  - (e) All (i) (ii) (iii)
-

**Q23.**

- (A) There has been a vast array of technological advancements available today.  
(B) Companies must continuously update their processes and systems to stay ahead in an ever-evolving digital landscape.  
(i) With the advent of continuous update  
(ii) Considering the vast array of  
(iii) Given the wide range of  
(a) Only (i)  
(b) Only (ii)  
(c) Both (i) and (ii)  
(d) Both (ii) and (iii)  
(e) All (i) (ii) (iii)

**Q24.**

- (A) The government pushed forward with its reform plans in the face of intense public scrutiny.  
(B) The government remained determined to bring about change.  
(i) In light of widespread criticism,  
(ii) In the face of intense public scrutiny,  
(iii) Amid growing criticism,  
(a) Only (i)  
(b) Only (ii)  
(c) Both (i) and (ii)  
(d) Both (ii) and (iii)  
(e) All (i) (ii) (iii)

**Directions (25-29):** In the question given below, a sentence is given with two blanks in it. Following the sentence three words are given. The same word will fit in both the blanks. Choose the word from the given options that best completes the sentence.

**Q25.** In the event to \_\_\_\_\_ the manager the subordinates stand outside the \_\_\_\_\_ to bring the manager decision in their favor.

- (I) Porch  
(II) Lobby  
(III) Sway  
(a) Only (I)  
(b) Both (I) and (II)  
(c) Only (II)  
(d) Both (II) and (III)  
(e) Only (III)

**Q26.** While she was working, she heard a sudden \_\_\_\_\_ of inspiration outside, which was caused by the \_\_\_\_\_ of light from the night star.

- (I) Burst  
(II) Blare  
(III) Flash
-

- (b) Both (I) and (II)
- (c) Only (II)
- (d) Both (II) and (III)
- (e) Both (I) and (III)

**Q27.** The philosopher endeavored to \_\_\_\_\_ the abstruse concepts during his lecture, though it proved arduous to \_\_\_\_\_ them without simplifying the intricate details.

- (I) Elucidate
- (II) Actuate
- (III) Mandate
- (a) Only (I)
- (b) Both (I) and (II)
- (c) Only (II)
- (d) Both (I) and (III)
- (e) Only (III)

**Q28.** The diplomat sought to \_\_\_\_\_ tensions between the two nations, hoping to \_\_\_\_\_ a peaceful resolution to the long-standing conflict.

- (I) Alleviate
- (II) Mitigate
- (III) Ameliorate
- (a) Only (I)
- (b) Both (I) and (II)
- (c) Only (II)
- (d) Both (II) and (III)
- (e) Only (III)

**Q29.** The lawyer sought to \_\_\_\_\_ the witness's testimony by questioning the inconsistencies, aiming to \_\_\_\_\_ the credibility of the opposing argument.

- (I) Undermine
- (II) Challenge
- (III) Sinuate
- (a) Only (I)
- (b) Both (I) and (II)
- (c) Only (III)
- (d) Both (II) and (III)
- (e) Only (II).

**Q30.** In each of the given question five sentences are given in which one is not coherent with others. Choose the incoherent statement as your answer.

- (a) Participating in recreational sports can improve physical health by promoting regular exercise and active movement.
  - (b) Many people find that exercising in groups enhances their social bonds and reduces feelings of isolation.
  - (c) Regular health checkups and medical screenings are essential for preventing chronic diseases.
  - (d) Group fitness activities often help individuals stay motivated and consistent in their fitness goals.
  - (e) Engaging in physical activities with friends or in a community setting can reduce stress and increase emotional well-being.
-

**Directions (31-34):** There are some series given below and each series contains one wrong term. Find out the wrong term from each series.

**Q31.** 8, 111, 231, 376, 546, 743, 969

- (a) 546
- (b) 969
- (c) 8
- (d) 111
- (e) 231

**Q32.** 100, 240, 480, 1344, 4300.8, 15482.88, 61931.52

- (a) 240
- (b) 61931.52
- (c) 15482.88
- (d) 1344
- (e) 100

**Q33.** 2, 338, 548, 668, 728, 751, 758

- (a) 2
- (b) 338
- (c) 751
- (d) 668
- (e) 758

**Q34.** 309, 516, 932, 1764, 3428, 6756, 13412

- (a) 1764
- (b) 309
- (c) 516
- (d) 6756
- (e) 932

**Q35.** There are two numbers A and B, while A is 33.33% less than B. The product of LCM and HCF of A and B is 294.

**Quantity I:** 450

**Quantity II:** LCM of  $(6A - 20)$  and  $(3B - 7)$

- (a) Quantity I > Quantity II
  - (b) Quantity I < Quantity II
  - (c) Quantity I  $\geq$  Quantity II
  - (d) Quantity I  $\leq$  Quantity II
  - (e) Quantity I = Quantity II or no relation
-

**Q36. Rohit spends 40% of his monthly income on rent,  $\frac{1}{3}$ rd of the remaining he spends on groceries. He invested the remaining income in three different schemes A, B and C in the ratio of 2 : 3 : 5 respectively. The difference between amount invested in scheme B and C is Rs 4000.**

**Quantity I:** Find the difference between Rohit monthly income and amount invested in scheme C.

**Quantity II:** 60000 Rs

- (a) Quantity I > Quantity II
- (b) Quantity I < Quantity II
- (c) Quantity I  $\geq$  Quantity II
- (d) Quantity I  $\leq$  Quantity II
- (e) Quantity I = Quantity II or no relation

**Q37. A and B entered into a business with investment of Rs P & Rs P+ 5000 respectively. After four months, A withdrew 40% of his initial investment and C joined the business with investment of Rs 6000. At the end of a year, the total profit is Rs 17150 and C received  $\frac{60}{343}$ th of the total profit. Find the profit share of B (in Rs.)?**

- (a) 9750
- (b) 9970
- (c) 9670
- (d) 9550
- (e) 9250

**Q38. An amount of Rs P invested in scheme A on compound interest at rate of 20% p.a. and same amount invested in scheme B on simple interest at rate of 20% p.a. At the end of two years, the difference between interest received from both schemes is Rs 260.**

**Quantity I:** If Rs  $\frac{3P}{4}$  is invested at rate of 6% p.a. for four years in simple interest, then find the interest received.

**Quantity II:** 1100 Rs

- (a) Quantity I > Quantity II
- (b) Quantity I < Quantity II
- (c) Quantity I  $\geq$  Quantity II
- (d) Quantity I  $\leq$  Quantity II
- (e) Quantity I = Quantity II or no relation

**Q39. Riya has an amount of Rs 6X and she invested  $\frac{1}{3}$ rd of amount in two different schemes A and B in the ratio of 1 : 7 respectively. From remaining, she paid Rs 2100 to her maid and remaining Rs P he invested in post office. If X : P = 3 : 5, then which of the following statement/s is or are correct?**

I. Amount invested in scheme B is more than the amount invested in post office.

II. Amount spend on maid is more than the amount spend on scheme A

III. Amount invested in scheme B equal to Amount spend on maid

- (a) All I, II and III
  - (b) Both I and II
  - (c) Only I
  - (d) Only III
  - (e) Both I and III
-

**Q40.** There is a right cylindrical vessel filled 75% of its capacity, which is equal to \_\_\_ cm<sup>3</sup>. The breadth of a rectangle is 10 cm more than the height and length of the rectangle is 4 cm more than the radius of the cylindrical vessel. The curved surface area of the cylindrical vessel is \_\_\_ cm<sup>2</sup>. Find which of the following value/s is or are come in the blank place. (Note: The curved surface area of the cylindrical vessel is greater than twice the area of the rectangle)

- I. 1155, 440
- II. 3696, 704
- III. 1386, 528
- (a) All I, II and III
- (b) Only I and II
- (c) Only I
- (d) Only III
- (e) Both II and III

**Q41.** Speed of a car is X km/hr and speed of a bus is twice of the speed of the car. The car starts from point A at 10 am and reached point B at 17 pm, while bus starts from point A to reach point B and it covers (672+2X) km in 3 hours. If speed of the car decreased by 25%, then, then find how much more time the car will take to reach point B (The car halt two times each for 5 minutes)?

- (a) 2 hours 40 minutes
- (b) 2 hours 35 minutes
- (c) 2 hours 30 minutes
- (d) 2 hours 10 minutes
- (e) 2 hours 05 minutes

**Q42.** The ratio of speed of a boat in still water and speed of stream is 4 : 1 respectively. The difference between time taken by the boat to cover D km downstream and upstream is 10 hours. (Note: Speed of the stream is 5 km/hr)

**Quantity I:** Find time taken by the boat to cover D-75 km downstream

**Quantity II:** Time taken by the to cover (D+45) km upstream

- (a) Quantity I > Quantity II
- (b) Quantity I < Quantity II
- (c) Quantity I ≥ Quantity II
- (d) Quantity I ≤ Quantity II
- (e) Quantity I = Quantity II or no relation

**Directions (43-48):** Read the information carefully and answer the questions below.

There are three companies X, Y and Z. Total number of type A pencil manufactured is 40% less than total number of type B pencils manufactured by all three companies. The ratio of total number of type B pencils manufactured by Z to total number of type B pencil manufactured by all three companies is 3 : 10. The number of type A pencils manufacture by X is equal to total number of pencils manufactured by Y. The number of type A pencils manufactured by Z and Y are equal. Total number of pencils manufactured by X are half of the total number of pencils manufacture by all three companies together.

**Note:** Total pencils manufactured by any company = (type A + type B) pencils manufactured

---

**Q43. If difference between total number of type B pencils manufactured by X and Y are 300, then find the sum of total number of type B pencils manufactured by Z and type A pencils manufactured by X.**

- (a) 2400
- (b) 1900
- (c) 1675
- (d) 1050
- (e) 2100

**Q44. The average number of type B pencils manufactured by X and Z is 1050. If total number of pencils manufactured by N is 25% more than that of X, then find the difference between sum of type B pencil manufactured by Z and number of type A pencils manufactured by Y and total number of pencils manufactured by N.**

- (a) 1500
- (b) 900
- (c) 1600
- (d) 1800
- (e) 1200

**Q45. Total number of pencils manufactured in M are equal four times of the total type A pencils manufactured by X and Z together. If difference between total pencils manufactured by M and total type B pencils manufactured by all three companies are 2000, then find total number of pencils manufactured by all three companies.**

- (a) 1200
- (b) 1600
- (c) 3200
- (d) 3000
- (e) 3600

**Q46. Find the ratio of type B pencils manufactured by Y to total pencils manufactured by Z.**

- (a) 3:4
- (b) 1:9
- (c) 1:5
- (d) 4:3
- (e) 2:1

**Q47. Type B pencils manufactured by all is A% of type A pencils manufactured by X. Find A.**

- (a) 240
  - (b) 250
  - (c) 175
  - (d) 105
  - (e) 210
-

**Q48. If the difference between type B pencils manufactured by Y and type A pencils manufactured by Z is D, then D is what percentage of type B pencils manufactured by Z.**

- (a) 66.66
- (b) 33.33
- (c) 25
- (d) CND
- (e) None of these

**Q49. Find the roots of the given equations and answer the following question.**

I.  $2x^2 - 11x + p = 0$

II.  $2y^2 - 15y + q = 0$

**Note: (i)** one of the roots of equation (I) is 2

**(ii)** one of the roots of equation (II) is three times the smaller root of equation (I)

**Find the product of p and q.**

- (a) 242
- (b) 262
- (c) 252
- (d) 212
- (e) 272

**Q50. The cost price of a product is Rs Y, and it is marked 60% above its cost price. If a retailer offers a 25% discount on the product and earns a profit of Rs 40.**

**Quantity I:** Find the marked price of the product (in Rs).

**Quantity II:** If cost price of an article is equal to selling price of the product and the article sold at 33.33% profit, then find the selling price of the article.

- (a) Quantity I > Quantity II
- (b) Quantity I < Quantity II
- (c) Quantity I ≥ Quantity II
- (d) Quantity I ≤ Quantity II
- (e) Quantity I = Quantity II or no relation

**Direction (51–55):** The table given below shows the total number of utensils (Glass and Plats) sold by four shops, percentage of glasses sold and number of plats sold by these four shops (A, B, C and D). Some values are missing in the tables, which you have to calculate if required. Read the table carefully and answer the questions.

Shops	Total utensils (Glass and Plats) sold	Percentage of glass sold	Number of plats sold
A	968	50%	
B		65%	
C		44%	504
D	900		

**Q51.** In shop D, the percentage range of number of glasses sold within  $8 < X < 30$  and X is an odd place multiple of 8. Find the number of plats sold by shop D?

- (a) 684
- (b) 620
- (c) 630
- (d) 636
- (e) 624

**Q52.** The number of plats sold by B is 146 more than three times of the difference between total number of utensils (Glass and Plats) sold by A and D. Find the sum of total number of utensils (Glass and Plats) sold by C and the number of glasses sold by B?

- (a) 1518
- (b) 1520
- (c) 1530
- (d) 1536
- (e) 1550

**Q53.** If the total number utensils (Glass and Plats) sold in Y is 200% more than the number of glasses sold by A and the number of plats sold by Y is  $\frac{3}{4}$ th of the total number of utensils (Glass and Plats) sold by the shop, then find the sum of total number of glasses sold by Y and C together?

- (a) 829
- (b) 719
- (c) 789
- (d) 759
- (e) 729

**Q54.** If the total number glasses sold by B is 414 less than the average number of total number of utensils (Glass and Plats) sold by A and D, then find total number of plats sold by shop B?

- (a) 180
- (b) 200
- (c) 300
- (d) 280
- (e) 240

**Q55.** If the average of total number of utensils (Glass and Plats) sold by all four shops is 822, then find the number plats sold by shop B?

- (a) 186
  - (b) 180
  - (c) 188
  - (d) 196
  - (e) 182
-

**Directions (56-60):** The bar graph given below shows percentage of people (male +female) not attended the seminar out of the total people in the city and percentage of male attended the seminar out of the total people attended the seminar from four different (A, B, C and D) cities. Read the graph carefully and answer the questions.

**Note:** Total people in a city = People (male + female) attending the seminar + people (male + females) not attending the seminar.

People attending/not attending the seminar = males + females

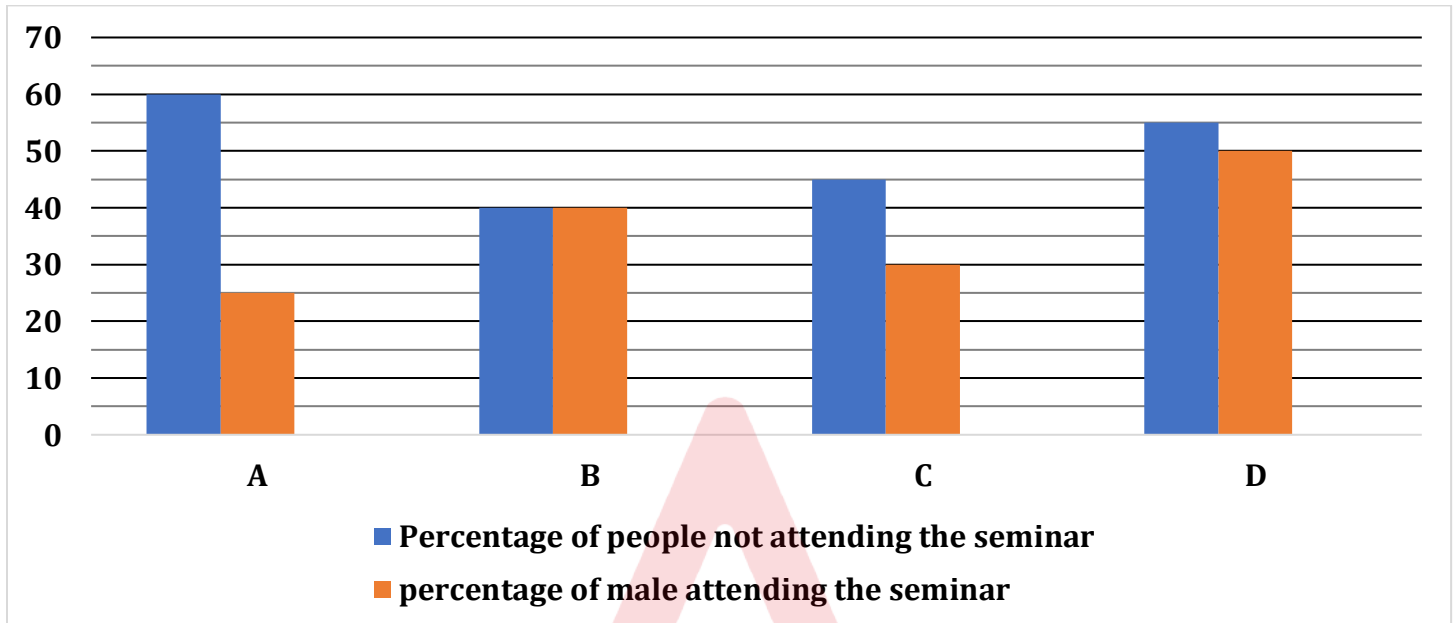

**Q56.** Total females attending the seminar from A is 1800 and total males not attending the seminar from B is 600. If the ratio of total males not attending the seminar from B to total people not attending the seminar from B is 3 : 10, then find total people in A are what percent more than total people in B.

- (a) 5%
- (b) 30%
- (c) 15%
- (d) 20%
- (e) 10%

**Q57.** The ratio of total males not attending the seminar from B to people not attending the seminar from B is 2 : 5. Total females attending the seminar from B is 2880 and total females not attending the seminar from C are 384 more than total males attending the seminar from same city. If total females not attending the seminar from C is 42% less than people not attended the seminar from C, then find the difference between males not attended the seminar from company B and C.

- (a) 524
- (b) 512
- (c)  $(8^3 + 12)$
- (d) Both (a) and (c)
- (e) 564

**Q58. If females attended the seminar from D is 2250 and the ratio of total females not attended the seminar to total males not attended the seminar is 7 : 3, then find difference between total females not attended the seminar and total males not attended the seminar from D.**

- (a) 1100
- (b) 2000
- (c) 2200
- (d) 1800
- (e) 2400

**Q59. If difference between total male and females attended the seminar from A is 1200 and total females attended the seminar from D is 2700, then find the ratio of total people not attended the seminar from D to total number of people in A.**

- (a) 11 : 9
- (b) 11 : 10
- (c) 11 : 8
- (d) 11 : 7
- (e) 13 : 11

**Q60. If the ratio of total people in A to that in C is 2 : 3 and difference between total females attending the seminar from both cities is 4440, then find average number of males attending the seminar from both the cities.**

- (a) 2980
- (b) 2180
- (c) 2780
- (d) 2280
- (e) 2580

**Directions (61-65): Study the following information carefully and answer the questions given below:**

Six persons A, B, C, D, E and F—live on six different floors of a building. The lower-most floor is numbered as 1, the floor immediately above it is numbered as 2 and so on till the topmost floor is numbered as 6. Each person has a different favourite fruit -Watermelon, Apple, Guava, Mango, Grapes and Pineapple—and they all want to visit six different Countries: Chile, Japan, Canada, Brazil, Norway and Italy.

More than two floors gap is there between A and the one who wants to visit Japan. The one who lives immediately below the person who wants to visit Japan likes Mango. There is two floors gap between the persons who like Mango and Pineapple. A lives below the one who wants to visit Japan. E lives four floors above A but doesn't live on the topmost floor. The number of persons live above F is two less than the number of persons live below the one who likes Grapes. There is one floor gap between the one who wants to visit Norway and E. More than one floor gap is there between the ones who like Pineapple and Watermelon. As many floors are there above A as below F. E doesn't like Watermelon and D doesn't like Guava. One floor gap is there between D and C who wants to visit Canada. A wants to visit Brazil. More than one floor gap is there between the ones who want to visit Brazil and Canada. C doesn't like Apple and Guava. The one who likes Apple doesn't visit Chile.

---

**Q61. Who among the following lives on second floor and wants to visit which country?**

- (a) D, Norway
- (b) B, Norway
- (c) D, Italy
- (d) The one who likes Pineapple, Brazil
- (e) A, Brazil

**Q62. How many floors are there between the one who likes Guava and D?**

- (a) Three
- (b) Two
- (c) One
- (d) None
- (e) Four

**Q63. Which among the following combination is correct?**

- (a) D – Pineapple, Italy
- (b) E – Guava, Chile
- (c) B – Grapes, Norway
- (d) E – Mango, Japan
- (e) None of these

**Q64. Who among the following lives four floors above A, likes which fruit and wants to visit which country?**

- (a) F – Watermelon, Chile
- (b) E – Guava, Japan
- (c) E – Mango, Italy
- (d) C – Mango, Canada
- (e) E – Watermelon, Japan

**Q65. The number of floors above the floor in which the person who wants to visit Chile lives is four less than the number of floors below the floor in which the person who wants to visit \_\_\_\_\_ lives.**

- (a) Canada
- (b) Norway
- (c) Italy
- (d) Japan
- (e) Brazil

**Directions (66-70): A number and word arrangement machine when given an input line of numbers rearranges them following a particular rule in each step. The following is an illustration of an input & its rearrangement.**

**Input: 65 of story 47 rooted 32 simplicity 82 the 93**

---

Step 2: rooted simplicity 65 of story 82 the 93 43 36

Step 3: story rooted simplicity of 82 the 93 43 36 54

Step 4: the story rooted simplicity of 93 43 36 54 93

Step 5: of the story rooted simplicity 36 43 54 93 82

Step 6: of the story rooted simplicity 36 43 54 82 93

**Step 6 is the last step of the above input as per the rules followed in the above steps. As per the above rule followed in the above steps, find out in each of the following questions the appropriate step for the given input.**

**Input: speed 56 bike 23 increasing 34 of 49 rapidly 76**

**Q66. How many elements are between 67 and bike in Step 5?**

- (a) Six
- (b) Seven
- (c) Three
- (d) Four
- (e) Five

**Q67. Which among the following number is present in Step 5?**

- (a) 23
- (b) 36
- (c) 46
- (d) 34
- (e) 87

**Q68. What is the sum of second number and fourth number from the right end in Step 6?**

- (a) 104
- (b) 110
- (c) 105
- (d) 114
- (e) 94

**Q69. Which element is present fourth to the left of third element from the right end in Step 4?**

- (a) of
- (b) 76
- (c) rapidly
- (d) increasing
- (e) None of these

**Q70. How many words are there to the right of the word bike in Step 3?**

- (a) None
  - (b) Two
  - (c) One
  - (d) Three
  - (e) Four
-

**Directions (71-75): Study the following arrangement carefully and answer the questions given below:**

Eight persons - A, B, C, D, E, F, G and H - sit around a square-shaped table. Four persons sit at the corners face inside and the remaining four persons sit in the middle of the sides face outside. Each of the person who sits at the corners has a different favourite flower: Lily, Rose, Tulip, and Carnation. Each of the person who sits at the middle of the sides of the table has a different favourite fruit: Mango, Banana, Apple and Guava. All the information is not necessarily in the same order.

H doesn't sit at corners. G sits third to the left of C. One person sits between the one who likes Guava and C. The one who likes Guava sits immediately to the right of A. B sits opposite to G. The one who likes Carnation sits second to the right of A. E sits third to the left of the one who likes Rose. Two persons sit between the ones who like Banana and Carnation. A is not an immediate neighbour of the one who likes Banana. The one who likes Banana sits opposite to E. Two persons sit between the ones who like Rose and Apple. D sits third to the right of the one who likes Apple. G doesn't like lily. H doesn't like Banana and Mango.

**Q71. Who among the following persons sits opposite to the person who likes Apple?**

- (a) The one who likes Guava
- (b) The one who likes Mango
- (c) F
- (d) D
- (e) None of these

**Q72. Which of the following statement is correct?**

- (a) Three persons sit between the ones who like carnation and Mango.
- (b) D is not an immediate neighbour of the one who likes Banana.
- (c) The one who likes Lily sits fourth to the right of C.
- (d) E and G are immediate neighbours
- (e) D face inside.

**Q73. Who among the following persons sits fifth to the left of D?**

- (a) C
- (b) The one who likes Mango
- (c) The one who sits second to the right of the one who likes Guava.
- (d) The one who likes Tulip
- (e) None of these

**Q74. Four of the following five are in the same group, who among the following does not belong to that group?**

- (a) H
  - (b) G
  - (c) F
  - (d) E
  - (e) C
-

**Q75. What is the position of the person who likes Carnation with respect to the person who likes Mango?**

- (a) Immediate left
- (b) Sixth to the left
- (c) Fifth to the right
- (d) Seventh to the left
- (e) Seventh to the right

**Q76. If in the given word "MALNOURISHED" if all the vowels are replaced with the succeeding letters and all the consonants are replaced with the preceding letter then all the letters are arranged in reverse alphabetical order from left end then find how many letters are there between fourth letter from right end and third letter from the left end according to English Alphabetical order?**

- (a) Ten
- (b) Nine
- (c) Eight
- (d) Five
- (e) Six

**Directions (77-81): Study the following information carefully and answer the questions given below:**

Seven persons - P, Q, R, S, T, U and V - were born in seven different years: 1972, 1975, 1976, 1982, 1987, 1993 and 2005, but not necessarily in the same order. Each person has purchased a different thing: Keys, Chains, Locks, Pins, Stapler, Locket and Glass. Their ages are counted as in the year 2024. All the information is not necessarily in the same order.

The one who was born in leap year purchased stapler. One person was born between the one who was born in leap year and T. The number of persons born before the one who purchased stapler is one more than the number of persons born after the one who purchased Pins. More than two persons were born between T and S who was born two persons before P. The one whose age is a prime number purchased Locket but that person is not the youngest person. More than two persons were born between the one who purchases Stapler and the one who purchased Glass. U is 7 years elder to Q. As many persons were born before U as after V. R doesn't purchased Glass. The Chains was purchased by the person who was born five persons before V. The one whose age is an odd number doesn't purchased Keys.

**Q77. Who among the following person purchased Locks and what was the age of that person?**

- (a) U - 48
- (b) Q - 42
- (c) S - 37
- (d) U - 49
- (e) S - 52

**Q78. In which year was the person who purchased S was born and what was the thing that S purchased?**

- (a) 1982, Locket
  - (b) 1987, Lock
  - (c) 1975, Keys
  - (d) 1987, Locket
  - (e) 1982, Keys
-

**Q79. How many persons were born between T and the person who purchased Pins?**

- (a) Two
- (b) Four
- (c) One
- (d) Three
- (e) Five

**Q80. What is the difference between the ages of the one who purchased Glass and R?**

- (a) 12
- (b) None of these
- (c) 30
- (d) 23
- (e) 29

**Q81. Four of the following five are similar in a certain way and related to a group, which among the following does not belong to that group?**

- (a) V
- (b) P
- (c) T
- (d) U
- (e) S

**Directions (82-84): Study the following information carefully and answer the given questions below:**

Ipshita started walking from Point A in the west direction for 3m and reached Point B. From Point B, she turned left and walked 7m and reached Point R. From Point R, she turned right and walked for 5m and reached Point K. From Point B, she turned right and walked 7m and reached Point C. From Point C, she turned left and walked for 8m and reached Point D.

From Point D, she turned right and walked for 9m and reached Point E. From Point E, she turned right again and walked for 7m and reached Point F. From Point F, she turned left and walked for 4m and reached Point I. From Point I, she turned right and walked for 5m and reached Point L. From Point L, she turned right and walked for 5m and reached Point O. From Point O, she turned left and walked for 3m and reached Point H.

**Q82. In which direction is Point L with respect to Point G?**

- (a) North-west
- (b) South-west
- (c) North-east
- (d) East
- (e) North

**Q83. What is the shortest distance between Point I and Point H?**

- (a) 11m
  - (b) 10m
  - (c) 8m
  - (d) 6m
  - (e) 12m
-

**Q84. Four of the following five are in the same group. Which among the following does not belong to that group?**

- (a) I-F
- (b) C-G
- (c) O-D
- (d) H-E
- (e) F-R

**Directions (85-88): Read the following information carefully and answer the questions that follow.**

In recent years, the Government of India launched several social welfare schemes aimed at providing direct financial assistance to the poor. One such scheme focused on depositing subsidies directly into the bank accounts of beneficiaries, which reduced the dependency on intermediaries. While many appreciated the transparency and efficiency of the scheme, a few argued that it left out those without access to banking facilities, especially in remote areas.

**Q85. Which of the following could be a reason for some people not supporting the scheme?** (I) Lack of banking facilities in remote and rural areas.

(II) The scheme involved the use of complex technology that many rural people were not familiar with.

(III) The scheme caused delays in the distribution of funds in some areas.

- (a) Only II and III
- (b) Only I and II
- (c) Only I and III
- (d) Only I
- (e) All of the above

**Q86. Which of the following can be assumed from the above statement?**

(I) The scheme helped in reducing corruption and the role of intermediaries in subsidies.

(II) A considerable portion of the rural population was left out of the benefits of the scheme.

(III) People living in urban areas benefited more from the scheme.

- (a) Only I and II
- (b) Only II and III
- (c) Only I and III
- (d) Only I
- (e) All of the above

**Q87. Which of the following could challenge the effectiveness of the scheme?**

(I) A report showed that many beneficiaries still relied on local agents to access their funds.

(II) The majority of people in rural areas did not have mobile phones, making it hard to use online banking services.

(III) A significant number of transactions were delayed due to technical glitches in the system.

- (a) Only I and II
  - (b) Only II and III
  - (c) Only I and III
  - (d) Only III
  - (e) All of the above
-

**Q88. Which of the following supports the motive behind the scheme?**

- (I) A large percentage of beneficiaries reported receiving their subsidies on time without any hassle.
  - (II) The number of people opening bank accounts in rural areas increased significantly after the scheme was launched.
  - (III) The scheme contributed to an increase in transparency in government subsidies distribution.
- (a) Only I and II
  - (b) Only II
  - (c) Only I and III
  - (d) Only II and III
  - (e) All of the above

**Directions (89-91): Each question consists of two conclusions followed by some statements. Consider the given conclusions to be true even if they seem to be at variance with commonly known facts. Read the conclusions and then decide which of the following statements is true for given conclusions.**

**Q89. Conclusions:**

- I. All Silver is Chain.
- II. Some Keys are not Lock.

**Statements:**

- (a) Some Silver are Lock. No Lock is Chain. Some Keys are not Chain.
- (b) Only a few Silver are Lock. Some Chain are Lock. Some Keys are Lock.
- (c) All Silver are Keys. All Keys are Chain. No Silver is Lock.
- (d) Every Lock is Chain. Some Silver are Lock. Some Chain are Keys.
- (e) No Lock is Chain. No Lock is Silver. All Keys are Chain.

**Q90. Conclusions:**

- I. Some Necklace being Earring is a possibility.
- II. No Earring is Ring.

**Statements:**

- (a) No Earring is Bracelet. All Bracelet are Necklace. Each Ring is Necklace.
- (b) Only a few Necklace are Bracelet. Some Bracelet are Ring. All Ring are Earring.
- (c) All Ring are Earring. No Earring are Necklace. Each Necklace is Bracelet.
- (d) All Earring are Bracelet. Some Ring are Necklace. No Bracelet is Ring.
- (e) Some Earring are not Necklace. Some Earring are Ring. No Ring is Bracelet.

**Q91. Conclusions:**

- I. Some Speakers are Headphones.
- II. All Phones are Air Pods.

**Statements:**

- (a) Some Air Pods are Phones. All Headphones are Air Pods. No Phones are Speakers.
  - (b) A few Headphones are Speakers. No Air Pods are Headphones. Some Headphones are Phones.
  - (c) Some Headphones are not Speakers. Some Air Pods are Phones. All Phones are Speakers.
  - (d) Only a few Speakers are Phones. All Phones are Headphones. Mostly Air Pods are Speakers.
  - (e) Each Phones are Speakers. Each Speakers are Air Pods. Some Phones are Headphones.
-

**Directions (92-95):** In a recent debate, there have been growing concerns about the increasing use of plastic and its impact on the environment. Environmentalists are urging the government to impose strict regulations on plastic production and usage, citing the harmful effects of plastic waste on ecosystems. Many businesses, however, argue that plastic is essential for packaging and that alternatives may increase costs for consumers.

**Q92. Which of the following strengthens the argument of environmentalists advocating for strict regulations on plastic?**

- (I) The rate of plastic recycling in many countries is less than 30%.
  - (II) Plastic alternatives, like biodegradable materials, are currently expensive but are more eco-friendly.
  - (III) Many species of marine animals have been found with plastic waste in their stomachs, leading to their deaths.
- (a) Only I and III
  - (b) Only II and III
  - (c) Only I and II
  - (d) Only III
  - (e) All of the above

**Q93. Which of the following weakens the businesses' argument for continued use of plastic? (I)**

- Governments across the world are offering subsidies for the development of plastic alternatives.
- (II) Consumers are becoming more eco-conscious and are willing to pay higher prices for sustainable products.
  - (III) Plastic is still the most durable and cost-effective packaging material available.
- (a) Only I and II
  - (b) Only III
  - (c) Only I
  - (d) Only II and III
  - (e) None of these

**Q94. Which of the following can be inferred from the passage?**

- (I) Governments are concerned about plastic waste and are taking action.
  - (II) The debate over plastic is primarily about balancing environmental impact and economic cost.
  - (III) Most businesses are against any form of regulation on plastic use.
- (a) Only I and II
  - (b) Only III
  - (c) Only I and III
  - (d) Only II
  - (e) All of the above
-

**Q95. What may be the consequences of imposing strict regulations on plastic production?**

- (I) Businesses may pass on the increased cost of alternatives to consumers.  
(II) The reduction in plastic waste could significantly improve oceanic ecosystems.  
(III) There may be a reduction in the overall packaging costs in the long run as more alternatives are developed.
- (a) Only II and III  
(b) Only I and II  
(c) Only I and III  
(d) Only II  
(e) All of the above

**Directions (96-99): In each of the following questions, a few statements have been given. Analyze the given statements and answer whether the data given in the statements are sufficient to answer the question.**

**Q96. Six persons – R, S, T, U, V and W book movie tickets for six different days starting from Monday to Saturday, but not necessarily in the same order. R booked movie tickets on which day?**

**Statement I:** Two persons booked movie tickets between U and W. V booked a movie ticket after U. S and V booked movie tickets adjacent to each other.

**Statement II:** More than one person booked a movie ticket between U and T. R booked a movie ticket before S.

**Statement III:** T booked a movie ticket two persons after W. T booked movie ticket after U. V booked a movie ticket before S.

- (a) If statement I alone is sufficient  
(b) If both statements I and statement II are sufficient  
(c) If both statements I and statement III are sufficient  
(d) If statement I, II & III together are sufficient  
(e) If only statement II is sufficient

**Q97. Six persons- A, B, C, D, E and F sit on a circular-shaped table, but not necessarily in the same order. All of them face towards the centre. What is the position of C with respect to E?**

**Statement I:** B sits second to the right of D. A is not an immediate neighbour of B.

**Statement II:** B sits second to the right of A who is not an immediate neighbour of C.

**Statement III:** One person sits between A and E who is not an immediate neighbour of D.

- (a) If statement I alone is sufficient  
(b) If both statements II and statement III are sufficient  
(c) If both statements I and statement III are sufficient  
(d) If statement I, II & III together are sufficient  
(e) If only statement II is sufficient

**Q98. In a certain coded language what is code for the word 'process initiated'?**

**Statement I:** In a certain coded language "process is fast" is coded as "my op ur" and "systematically initiated" is coded as "tv yu"

**Statement II:** In a certain coded language "legal initiated" is coded as "ts tv" and "the fast system" is coded as "pi kl ur"

---

**Statement III:** In a certain coded language “process slowly” is coded as “my mi” and “official matters” is coded as “ik mk”

- (a) If statement I alone is sufficient
- (b) If both statements I and statement II are sufficient
- (c) If both statements I and statement III are sufficient
- (d) If statement I, II & III together are sufficient
- (e) If only statement II is sufficient

**Q99. In a family of eight persons – M, N, O, P, Q, R, S and T. No single parent is there in this three-generation family. How is S related to M?**

**Statement I:** S is married to N. P is the sister of T. Q is the son-in-law of O.

**Statement II:** N is the father of P. R is the brother of P. O and T are married. T is the mother of M.

**Statement III:** N is the wife of S. Q is the daughter of O.

- (a) If statement I alone is sufficient
- (b) If both statements I and statement II are sufficient
- (c) If both statements I and statement III are sufficient
- (d) If statement I, II & III together are sufficient
- (e) If only statement II is sufficient

**Directions (100-103): Study the following information carefully and answer the questions given below:**

A certain number of persons are seated in a row facing north and they are from different cities. E sits sixth to the right of the person who is from Pune. Two persons sit between the ones who are from Mumbai and Kanpur. The one who is from Kanpur sits immediately to the right of S. Two persons sit between the one who is from Kanpur and E. W sits fourth from left of S. Three persons sit between P and W who is from Delhi. P sits third from one of the ends. Q is from Lucknow. The number of persons sit between P and E is same as the number of persons sit between the ones who are from Mumbai and Lucknow. The one who is from Lucknow sits to the right of the one who is from Mumbai. Q sits third to the left of V who sits at one of the extreme ends. The one who sits immediate left of O is from Kolkata. O sits third to the left of Q and is from Kanpur. The one who sits sixth to the right of O is from Banaras.

**Q100. Which of the following combination is correct?**

- (a) S - Mumbai
- (b) S - Pune
- (c) V - Banaras
- (d) E - Pune
- (e) E - Banaras

**Q101. How many persons sit in this row?**

- (a) 20
  - (b) 25
  - (c) 18
  - (d) 19
-

**Q102. What is the position of E with respect to the person from Banaras?**

- (a) Ninth to the right
- (b) Eighth to the left
- (c) Thirteenth to the left
- (d) Ninth to the left
- (e) Tenth to the left

**Q103. Which of the following statements is/are false?**

- I. O sits to the right of V
  - II. Three persons sit between E and S.
  - III. P is not from Pune
- (a) Only I
  - (b) Only II
  - (c) Only III
  - (d) Only I and II
  - (e) All I, II and III

**Q104. In the word "ABANDONED", if we use the second, fourth, sixth, and ninth letters from the left end, then which of the following will be the first letter from the right end of the meaningful word thus formed. If more than one such meaningful word is formed mark X as your answer. If no meaningful word is formed, mark Z as your answer?**

- (a) B
- (b) Z
- (c) X
- (d) D
- (e) N

**Directions (105-108): Study the following information carefully and answer the questions given below:**

Seven persons – A, B, C, D, E, F and G are comparing their weights in decreasing order from left to right, but not necessarily in the same order.

E is heavier than C who is lighter than A. Less than three persons are lighter than A. C is heavier than D. More than two persons weigh between D and G. G is heavier than B who is lighter than F. F is heavier than E. B is heavier than E. G is not the heaviest person. The one who weighs immediately more than E weigh 126Kg.

**Q105. Who among the following is the third heaviest?**

- (a) B
  - (b) G
  - (c) E
  - (d) F
-

**Q106. How many persons weigh between F and A?**

- (a) Five
- (b) Two
- (c) Three
- (d) Four
- (e) None

**Q107. If the sum of weights of B and C is 170Kg and the sum of weights C and A is 104Kg then what is the possible weight of E?**

- (a) 102Kg
- (b) 56Kg
- (c) 72Kg
- (d) 130 Kg
- (e) Either 72Kg or 102 Kg

**Q108. How many persons weigh more than C?**

- (a) Five
- (b) Two
- (c) Three
- (d) Four
- (e) Six

**Directions (109-112): Read the following passage carefully and answer the questions given below it.**

The increasing rate of urbanization across the world has brought significant changes to the environment. Deforestation, pollution, and a rising level of greenhouse gases have been some of the major outcomes of this shift towards urban living. Many experts suggest that the lack of proper planning and sustainable practices in urban development is responsible for a large share of these problems. Additionally, the surge in population in urban areas has led to overconsumption of resources, contributing further to environmental degradation. The United Nations has emphasized that it is essential for governments to integrate sustainable strategies to manage urban growth and mitigate its adverse effects on the environment.

**Q109. What could be inferred as one of the main reasons for environmental degradation according to the passage?**

- (I) Urbanization without proper planning has led to resource overconsumption.
  - (II) Governments around the world have failed to implement sustainable practices in urban areas.
  - (III) The increase in population in rural areas has no impact on environmental issues.
- (a) Only I
  - (b) Only I and II
  - (c) Only II and III
  - (d) Only III
-

**Q110. Which of the following actions could be recommended to alleviate the environmental degradation mentioned in the passage?**

- (I) Implementing sustainable urban development practices.
  - (II) Reducing the population growth rate in urban areas.
  - (III) Enhancing deforestation measures to make way for more urban expansion.
- (a) Only I
  - (b) Only I and II
  - (c) Only II and III
  - (d) Only III
  - (e) All of the above

**Q111. Which of the following can be inferred as a major consequence of unplanned urbanization?**

- (I) Increase in pollution levels in urban areas.
  - (II) Overconsumption of natural resources.
  - (III) Better access to healthcare and education.
- (a) Only I
  - (b) Only II
  - (c) Only I and II
  - (d) Only III
  - (e) All of the above

**Q112. Which of the following negates the inference drawn in the passage?**

- (I) Urban areas have become more sustainable over the last decade due to government efforts.
  - (II) The primary cause of environmental degradation is rural deforestation rather than urban expansion.
  - (III) Urbanization has reduced the amount of pollution worldwide by promoting technological advancements.
- (a) Only I
  - (b) Only I and II
  - (c) Only II and III
  - (d) Only III
  - (e) None of them

**Directions (113-115): Study the following information carefully and answer the questions given below:**

In a family of nine persons – D, E, F, G, H, I, J, K and L there is no single parent and three married couples in the family. I is the daughter of J who is the brother of E. G is the brother-in-law of E. H is daughter of F who is the wife of D. D is the brother-in-law of L. H is the sister of E. E is the brother-in-law of K. L is the sister-in-law of D.

**Q113. How is I related to D?**

- (a) Son
  - (b) Daughter
  - (c) Grandson
  - (d) Granddaughter
-

**Q114. Who among the following is the daughter-in-law of D?**

- (a) H
- (b) J
- (c) None of these
- (d) I
- (e) K

**Q115. If T is married to L, then how many male members are there in the family?**

- (a) Six
- (b) Four
- (c) Three
- (d) Five
- (e) None of these

**Q116. In the number '64376759247', if all the even digits are added by 2 and all the odd digits are subtracted by 2. Find the sum of the digits which are placed at odd positions in the new number formed after rearrangement?**

- (a) 17
- (b) 27
- (c) 28
- (d) 29
- (e) 24

**Directions (117-120): Read the passage carefully and answer the questions that follow.**

**Governments across the world have been focusing on the development of renewable energy sources to combat the ever-growing threat of climate change. Despite these efforts, fossil fuels continue to dominate the energy sector, contributing to increased carbon emissions. According to a report by the Global Energy Institute, renewable energy production has seen a steady rise but remains insufficient to meet the global energy demand. Additionally, financial constraints and the lack of infrastructure in developing countries are major obstacles in the transition to cleaner energy.**

**Q117. Which of the following reasons can be inferred as to why fossil fuels continue to dominate the energy sector?**

- (I) The cost of production of renewable energy is significantly higher than fossil fuels.
  - (II) Financial constraints and lack of infrastructure hinder the transition to renewable energy, especially in developing countries.
  - (III) Governments are not focused on combating climate change, which allows fossil fuels to dominate.
- (a) Only I
  - (b) Only II
  - (c) Only II and III
  - (d) Only I and II
-

**Q118. What should developing countries focus on to reduce dependence on fossil fuels according to the passage?**

- (I) Improve financial support and infrastructure for renewable energy production.
  - (II) Invest more in research and development of renewable energy technologies.
  - (III) Encourage the use of hybrid energy solutions combining renewable and non-renewable sources.
- (a) Only I
  - (b) Only I and II
  - (c) Only III
  - (d) Only II and III
  - (e) All of the above

**Q119. Which of the following can be concluded from the passage regarding the global energy sector?**

- (I) There has been some progress in renewable energy production, but it is not enough to meet the global demand.
  - (II) Financial constraints are the only reason for the slow transition to renewable energy.
  - (III) Fossil fuels remain the dominant source of energy due to their cheaper production costs.
- (a) Only I
  - (b) Only II
  - (c) Only I and III
  - (d) Only I and II
  - (e) All of the above

**Q120. Which of the following weakens the argument presented in the passage?**

- (I) A report from the World Energy Organization claims that renewable energy has surpassed fossil fuels in some developed countries.
  - (II) Research shows that renewable energy technology is rapidly becoming more affordable, and the cost is expected to decrease further in the coming years.
  - (III) The transition to renewable energy is delayed primarily due to a lack of political will rather than financial constraints.
- (a) Only I and II
  - (b) Only I
  - (c) Only II
  - (d) Only I and III
  - (e) None of the above

## Solutions

**S1. Ans.(b)**

**Sol.** The passage explains that the U.S. is concerned about Myanmar's patent system potentially not meeting international standards, which could "create barriers for U.S. businesses seeking to protect their IP in Myanmar, leading to higher costs and potential legal disputes." Therefore, option (b) captures the main

---

**Analysis:**

(a) The U.S. is concerned that Myanmar's patent system will result in increased taxes for American companies, making it harder for them to conduct business in the country.

- **Explanation:** This option is incorrect because the passage does not mention any concerns about taxes. The primary concern revolves around IP protection standards, not taxation.

(b) The U.S. believes that it may lead to higher operational costs for U.S. businesses, as they will need to comply with different and potentially less reliable IP protection standards.

- **Explanation:** This is the correct option. The passage clearly states that the U.S. is worried about the inconsistency between Myanmar's patent system and international standards, which "could create barriers" and result in "higher costs and potential legal disputes."

(c) The U.S. government fears that it will make it easier for U.S. companies to register their intellectual property without facing international scrutiny, which may reduce transparency.

- **Explanation:** This option is incorrect because the passage does not suggest that Myanmar's system would make it easier to register IP or reduce scrutiny. Instead, the concern is that it will be more difficult for U.S. companies to protect their IP.

(d) Myanmar's decision could increase the likelihood of innovative goods in the market, harming American businesses and consumers globally.

- **Explanation:** This option is incorrect and misleading. The passage expresses concern about counterfeit goods, not innovative goods. The risk is that weak IP protection will lead to more counterfeit products, not innovation.

(e) The U.S. is concerned that Myanmar's new patent system could limit foreign investments, as it may not offer the same legal protections provided by international IP agreements.

- **Explanation:** While this is a valid concern, it is a secondary issue. The primary focus in the passage is on the increased operational costs and legal challenges that U.S. businesses might face.

**S2. Ans.(c)**

**Sol.** The passage emphasizes that "adhering to international IP agreements is essential for countries involved in global commerce, as it ensures the protection of businesses and inventors." This implies that the U.S. supports these agreements to protect global trade, which is reflected in option (c).

**Analysis:**

(a) The U.S. sees international IP agreements as useful but believes that countries like Myanmar should have the freedom to adapt them to their national interests without significant consequences for global trade.

- **Explanation:** This option is incorrect because the passage does not suggest that the U.S. believes countries should have the freedom to adapt IP agreements to their national interests. Instead, the U.S. stresses the importance of adhering to global standards.

(b) The U.S. views international IP agreements as a barrier to innovation, which reduces the ability of countries to create independent IP systems.

- **Explanation:** This option is incorrect and contradicts the passage. The U.S. supports international IP agreements, seeing them as essential for protecting innovation, not a barrier to it.

(c) The U.S. believes that they are essential for ensuring the protection of businesses and inventors involved in global commerce, thereby safeguarding trade relations and foreign investments.

- **Explanation:** This is the correct option. The passage emphasizes that adhering to international IP agreements "ensures the protection of businesses and inventors" and is crucial for global trade,
-

**(d)** The U.S. argues that international IP agreements are primarily designed to protect developing nations' intellectual property.

- **Explanation:** This option is incorrect because the passage does not mention any special focus on developing nations. Instead, the U.S. emphasizes the global importance of IP agreements for all businesses and trade.

**(e)** The U.S. maintains that international IP agreements are important, and they should be applied when the majority of trading partners agree to adopt them simultaneously to avoid competitive disadvantages.

- **Explanation:** This option is incorrect because the passage does not mention applying IP agreements only when most trading partners agree. The U.S. stresses consistent adherence to international IP frameworks, regardless of other countries' actions.

### S3. Ans.(d)

**Sol.** The passage directly states that the U.S. is concerned about Myanmar's actions possibly "diluting protections provided under frameworks like Section 103," making it harder for U.S. companies to protect their trademarks in the country. This makes option (d) the most accurate. While (c) discusses the remedies Section 103 provides, it does not directly capture the U.S. concern as well as (d) does. Options (a), (b), and (e) present incorrect interpretations of the passage's message.

#### Analysis:

**(a)** The U.S. wants to promote Section 103 globally to ensure that all countries follow the same standards for trademark and patent protection.

- **Explanation:** This option is incorrect. The passage does not suggest that the U.S. is trying to promote Section 103 globally. Instead, the focus is on using Section 103 as a benchmark for reliable trademark protection in Myanmar.

**(b)** The U.S. believes that Section 103 offers superior protection for U.S. businesses and should be adopted by Myanmar as part of its national patent system to avoid legal conflicts.

- **Explanation:** This option is incorrect. The passage does not say the U.S. is advocating for the full adoption of Section 103 by Myanmar. The U.S. is concerned about the dilution of protections for trademarks rather than suggesting Myanmar should directly adopt this act.

**(c)** The U.S. emphasizes Section 103 because it provides legal remedies such as injunctions, damages, and the seizure of infringing goods, which could help American businesses to perpetuate in the longer run.

- **Explanation:** This option is partially correct but incomplete. While Section 103 indeed provides legal remedies to protect trademarks, the answer does not fully address the U.S.'s specific concerns regarding Myanmar's withdrawal from international frameworks.

**(d)** The U.S. is concerned that Myanmar's actions may dilute protections provided by frameworks like Section 103, making it harder for U.S. companies to safeguard their trademarks in the country.

- **Explanation:** This is the correct option. The passage explicitly states that the U.S. fears Myanmar's withdrawal from international IP agreements may "dilute protections" provided by frameworks such as Section 103, affecting U.S. businesses' ability to protect their trademarks in Myanmar.

**(e)** The U.S. is concerned that Section 103 gives too much power to foreign businesses, undermining the competitiveness of American companies in countries like Myanmar.

- **Explanation:** This option is incorrect because there is no mention in the passage that Section 103 gives excessive power to foreign businesses. The concern lies in the lack of protection for U.S. companies, not
-

**S4. Ans.(b)**

**Sol.** The passage clearly states that "insufficient IP protection may lead to an increase in counterfeit goods, harming both businesses and consumers." Option (b) accurately reflects this risk, while the other options misinterpret or contradict the negative consequences outlined in the passage. Options (a), (c), (d), and (e) either downplay the potential harm or suggest benefits where the passage indicates risks.

**Analysis:**

**(a)** U.S. businesses may benefit from reduced competition in Myanmar's market due to less stringent IP regulations, allowing them to operate with fewer legal restrictions and challenges from local competitors.

- **Explanation:** This option is incorrect. The passage discusses risks related to weak IP protections, such as financial losses and counterfeit goods, rather than the benefits of reduced competition for U.S. businesses.

**(b)** Insufficient protection under Myanmar's IP system could result in an influx of counterfeit goods, negatively affecting not only U.S. businesses through financial losses but also harming consumers by reducing the quality and reliability of available products.

- **Explanation:** This is the correct option. The passage clearly states that a weak IP system in Myanmar "could encourage counterfeiting" and undermine the protections American companies rely on globally, harming both businesses and consumers.

**(c)** The lack of alignment with global IP standards may give U.S. companies an opportunity to evade international scrutiny, allowing them to operate with more flexibility in protecting their intellectual property.

- **Explanation:** This option is incorrect because the passage emphasizes the negative consequences of weak IP protection, not that U.S. businesses would benefit from evading scrutiny.

**(d)** Myanmar's patent system could encourage greater investment in the country by lowering the costs associated with intellectual property registration and litigation, making it easier for U.S. businesses to enter the market.

- **Explanation:** This option contradicts the passage. The U.S. is concerned that a weak IP system could discourage investment, not encourage it.

**(e)** A weaker IP system in Myanmar could allow U.S. businesses to dominate the market, as fewer foreign companies will be interested in investing in a country with unreliable intellectual property protection laws.

- **Explanation:** This option is incorrect because the passage emphasizes risks like counterfeit goods and financial losses for U.S. businesses, rather than any potential benefits of dominating the market due to reduced foreign competition.

**S5. Ans.(c)**

**Sol.** The passage mentions two significant concerns: (I) U.S. companies could face legal battles and financial losses, and (II) there could be an increase in counterfeit goods, harming businesses and consumers. However, (III) is incorrect, as the passage highlights that Myanmar's withdrawal could potentially harm trade relations rather than strengthen them. Therefore, the correct answer is (c), both (I) and (II).

**Analysis:**

**(a)** Only (I)

- **Explanation:** This option is incorrect. While (I) is a valid concern, the passage also mentions the rise in
-

**(b)** Only (II)

- **Explanation:** This option is incorrect. While (II) is mentioned, the passage also discusses legal and financial challenges for U.S. businesses (I).

**(c)** Both (I) and (II)

- **Explanation:** This is the correct option. The passage highlights that U.S. businesses may face "legal battles and financial losses" (I) and that a weak IP system "could encourage counterfeiting" (II).

**(d)** Both (I) and (III)

- **Explanation:** This option is incorrect. While (I) is correct, (III) is inaccurate, as the passage does not suggest that Myanmar's withdrawal would improve trade relations with the U.S. Instead, it suggests the opposite—that trade relations could be disrupted.

**(e)** All (I), (II), and (III)

- **Explanation:** This option is incorrect because (III) is not supported by the passage. The passage does not indicate that Myanmar's withdrawal would foster improved trade relations with the U.S.

**S6. Ans.(a)**

**Sol.** The correct answer is:

**(a) A strong IP system attracts foreign investment by securing innovations.**

This sentence logically fits the blank because the passage is discussing the importance of IP protections in attracting foreign investments and boosting economic development. It reinforces the point that participating in global IP agreements would help Myanmar attract investors by ensuring their innovations are secure.

The other options serve as distractors:

**(b)** contradicts the idea that Myanmar stepping away from global agreements poses a risk to investor confidence.

**(c)** is incorrect because the passage stresses that investor confidence is indeed influenced by IP protections.

**(d)** is not correct, as it goes against the main argument that strong IP protections attract, not repel, foreign investment.

**(e)**, while valid, is too specific and doesn't directly link IP protections to attracting foreign investment, which is the main argument in this context.

**S7. Ans.(c)**

**Sol.** The passage discusses how a weak IP system in Myanmar "could encourage counterfeiting and undermine the protections that American companies rely on globally." This would lead to financial losses and brand damage for U.S. companies, making option (c) the correct answer.

**Analysis:**

**(a)** U.S. companies may need to collaborate with Myanmar's government to co-develop stronger IP protections.

- **Explanation:** This option is incorrect because the passage does not mention any collaboration between U.S. companies and the Myanmar government to develop stronger IP protections.

**(b)** U.S. companies may benefit from reduced legal regulations, making it easier to operate in Myanmar.

- **Explanation:** This option is incorrect. The passage discusses the negative consequences of a weak IP system, such as counterfeiting and financial losses, rather than suggesting that U.S. businesses would

(c) U.S. businesses may face difficulties from a surge in counterfeit products, leading to monetary losses and a decline in brand credibility.

- **Explanation:** This is the correct option. The passage explains that a weak IP system in Myanmar could "encourage counterfeiting," which would harm U.S. businesses through financial losses and damage to their brands.

(d) U.S. companies may enjoy greater freedom in Myanmar due to weaker IP enforcement, allowing them to bypass international restrictions.

- **Explanation:** This option is incorrect because the passage emphasizes the risks U.S. companies face due to weak IP protection, not greater freedom or flexibility in operations.

(e) U.S. companies may face stricter legal penalties for failing to comply with Myanmar's new IP system.

- **Explanation:** This option is incorrect because the passage does not mention stricter legal penalties for U.S. companies; the focus is on the risks posed by insufficient protection under Myanmar's new system.

### S8. Ans.(b)

**Sol.** This conclusion can be inferred from the passage, which discusses concerns that Myanmar's independent patent system might not align with international standards, potentially complicating the protection of intellectual property for foreign companies and leading to legal challenges.

#### Analysis:

(a) Myanmar's independent patent system will prevent foreign companies from facing legal challenges.

- **Explanation:** This option is incorrect because the passage suggests that Myanmar's independent patent system could increase legal challenges for foreign companies, not prevent them.

(b) Establishing a unique patent system may lead to more complex legal disputes for foreign businesses.

- **Explanation:** This is the correct option. The passage states that Myanmar's patent system might not meet international standards, leading to "higher costs and potential legal disputes" for foreign businesses like U.S. companies.

(c) Countries with strong IP protection experience higher levels of IP violations.

- **Explanation:** This option is incorrect because the passage argues that strong IP protection reduces issues like counterfeiting, not increases them.

(d) A strong IP protection system has no impact on a country's economic losses from intellectual property violations.

- **Explanation:** This option is incorrect because the passage implies that strong IP protection is critical for preventing economic losses and maintaining investor confidence.

(e) Foreign businesses will prefer to invest in countries with weaker IP protection systems.

- **Explanation:** This option is incorrect. The passage highlights that weaker IP protection could reduce foreign investment, as businesses rely on strong IP frameworks to protect their interests.

### S9. Ans.(d)

**Sol.** This conclusion is supported by the passage, which highlights concerns from the U.S. regarding Myanmar's decision to establish its own patent system. The U.S. fears that this move could create inconsistencies with international standards, making it harder for foreign businesses to protect their

---

**Analysis:**

(a) Myanmar will see an increase in foreign investments due to its unique IP framework.

- **Explanation:** This option is incorrect. The passage suggests that Myanmar's deviation from international standards may discourage foreign investment, as investors rely on strong, consistent IP protections.

(b) U.S. companies may find it easier to protect their intellectual property in Myanmar.

- **Explanation:** This option is incorrect because the passage indicates that U.S. companies would face greater difficulties protecting their IP in Myanmar due to inconsistent protections.

(c) Myanmar's move could encourage other countries to follow suit and establish their own patent systems.

- **Explanation:** This option is not supported by the passage, which does not suggest that other countries would be inspired to create their own independent patent systems as a result of Myanmar's actions.

(d) Foreign companies may face difficulties in protecting their trademarks and patents in Myanmar, potentially leading to economic and legal disputes.

- **Explanation:** This is the correct option. The passage explains that Myanmar's independent patent system could lead to "higher costs and potential legal disputes" for U.S. companies, implying difficulties in protecting trademarks and patents.

(e) Counterfeit goods will decline as Myanmar establishes its independent patent system.

- **Explanation:** This option is incorrect. The passage suggests the opposite: that weak IP protection in Myanmar could encourage an increase in counterfeit goods, not a decline.

**S10. Ans.(e)****Sol. Correct Sequence:**

**B - A - D - C**

**Explanation:**

1. **B** introduces the topic by explaining that the Unified Pension Scheme aims to merge different pension systems into one streamlined structure.
2. **A** follows by describing the scheme's goal of offering a balanced solution between retirees' financial security and government fiscal responsibility.
3. **D** adds that the unified structure will help lower administrative costs and ensure fairer distribution of benefits.
4. **C** concludes by explaining how this approach addresses both employees' demands for higher pensions and the government's ability to fund the program.

**S11. Ans.(c)****Sol. Correct Sequence:**

**A - B - D - C**

**Explanation:**

1. **A** introduces the topic by stating that hydropower projects are promoted as a renewable energy solution for rising electricity demands.
  2. **B** follows by highlighting the environmental and social challenges posed by these projects, such as ecosystem disruption and displacement.
  3. **D** elaborates on the challenge of responsibly developing hydropower while minimizing harm.
  4. **C** concludes by emphasizing the need to strike a balance between energy generation and environmental
-

**S12. Ans.(b)**

**Sol.** The idiom "taken aback" means to be surprised or shocked, usually in an unexpected or abrupt way. It does not relate to physically stepping back or moving.

- **Sentence (A)** uses the idiom correctly because it expresses being surprised by sudden news of a promotion.
- **Sentence (B)** is incorrect, as it confuses "taken aback" with physically stepping back for a better view.
- **Sentence (C)** is also incorrect, as it mistakenly refers to being "taken aback" by strong wind, which implies a physical effect rather than a surprising or shocking situation.

Therefore, the correct answer is **(b) Only A**.

**S13. Ans.(c)**

**Sol.**

The idiom "back in the saddle" means to return to doing something after a break or setback, often involving resuming a task, job, or activity that one is familiar with. It originates from horseback riding but is used figuratively.

- Sentence A is correct because it refers to someone returning to training after an injury, which fits the meaning of "back in the saddle."
- Sentence B is incorrect because the idiom "back in the saddle" is about resuming work or activity after a break or setback, not relaxing on a vacation.
- Sentence C is correct because it indicates someone returning to painting after a long break, which aligns with the idiom.

Therefore, the correct answer is:

(c) Both A & C.

**S14. Ans.(d)**

**Sol.** The idiom "keep the ball rolling" means to maintain momentum or continue progressing in an activity, task, or process. It implies sustaining an ongoing effort.

- **Sentence (A)** uses the idiom correctly, as it refers to maintaining focus and momentum despite a challenge.
- **Sentence (B)** is correct, referring to the entrepreneur keeping up the momentum after securing the first round of investment.
- **Sentence (C)** is also correct, as the coach is advising the team to continue their effort after a successful moment.

Therefore, the correct answer is **(d) All A, B, C**.

**S15. Ans.(d)**

**Sol.** Let's break down the sentence and analyze the incorrect placements:

The sentence is:

"Sampoornata Abhiyan is an initiative **empowerment (A)** at promoting **education (B)** development and **aimed (C)** through **holistic (D)**, skill-building, and community welfare programs, **particularly (E)** in

---

**Analysis of Incorrect Placements:****1. Empowerment (A):**

- o **Incorrect Placement:** "Empowerment" is incorrectly placed. It should describe the outcome or goal of the initiative. The word **aimed (C)** should be in this position, as the initiative is **aimed at** promoting development.
- o **Correct Swap: Empowerment (A)** should be swapped with **aimed (C)**, as it makes more sense to say the initiative is **aimed at promoting** development.

**2. Education (B):**

- o **Incorrect Placement:** The word "education" should be connected with **holistic** development, meaning a comprehensive approach that includes multiple aspects like education, skill-building, etc.
- o **Correct Swap: Education (B)** should be swapped with **holistic (D)** because **holistic development** is a more suitable phrase, and **education** fits better when paired with other aspects like skill-building.

**Correct Swapping:**

- **A-C:** "Aimed" should replace "empowerment," as it is aimed at promoting development, and "empowerment" should replace "aimed," indicating a focus on empowerment.
- **B-D:** "Holistic development" is a more fitting phrase, so **education (B)** and **holistic (D)** should be swapped.

**Corrected Sentence:**

"Sampoornata Abhiyan is an initiative **aimed (A)** at promoting **holistic (D)** development and **empowerment (C)** through **education (B)**, skill-building, and community welfare programs, **particularly (E)** in underprivileged areas."

**Conclusion:**

- **A-C:** "Aimed" is more appropriate in the first part of the sentence, and "empowerment" describes the initiative's goal.
- **B-D:** "Holistic development" is the correct phrase, and "education" fits better in the context of skill-building.

Thus, the correct answer is option **(d) A-C & B-D**.

**S16. Ans.(a)**

**Sol.** Let's analyze the sentence:

"The National Financial Reporting Authority ensures the **quality (A)** of financial **regulating (B)** by **reporting (C)** and overseeing audit practices, **financial (D)** transparency and accountability in **promoting (E)** statements."

**Analysis:**

- **"Quality (A)"** is correctly placed as it refers to the standard or excellence the Authority ensures.
  - **"Regulating (B)"** is incorrectly placed. The correct word should be **reporting** because the Authority ensures the quality of **financial reporting**.
  - **"Reporting (C)"** is incorrectly placed in this context. The word **regulating** fits better here because the Authority regulates audit practices.
  - **"Financial (D)"** is incorrectly placed as it describes transparency and accountability related to financial statements.
  - **"Promoting (E)"** is incorrectly placed. The correct word here should be **statements** since the Authority **financial statements**
-

**Incorrect Placement and Correct Swapping:****1. Regulating (B):**

- o **Incorrect Placement:** "Regulating" is not appropriate here because the sentence refers to the quality of **financial reporting**, not the act of regulation.
- o **Correct Swap: Reporting (C)** should replace **regulating (B)** because the Authority ensures the quality of **financial reporting**. This makes **B-C** the correct swap.

**2. Promoting (E):**

- o **Incorrect Placement:** "Promoting statements" does not make sense in this context. The correct word should refer to **statements** that are connected with **transparency and accountability** in financial processes.
- o **Correct Swap: Financial (D)** should replace **promoting (E)** because **financial statements** is the correct phrase. Therefore, **D-E** is the correct swap.

**Corrected Sentence:**

"The National Financial Reporting Authority ensures the **quality (A)** of financial **reporting (B)** by **regulating (C)** and overseeing audit practices, **promoting (D)** transparency and accountability in **financial (E)** statements."

Thus, the correct answer is option **(a) B-C & D-E**.

**S17. Ans.(d)**

**Sol.** The sentence is:

"Tarang Shakti-2024 **challenges (A)** on improving strategic **defense (B)** capabilities and fostering collaboration between **address (C)** forces to **armed (D)** evolving security **focuses (E)**."

**Analysis of Incorrect Placements:****1. Challenges (A):**

- o **Incorrect Placement:** The word "challenges" does not fit well with the idea of improving capabilities and fostering collaboration. The word should refer to the evolving security issues, making "focuses" (E) more suitable here.
- o **Correct Swap: Challenges (A)** should be swapped with **focuses (E)** because Tarang Shakti focuses on improving capabilities and collaboration.

**2. Address (C):**

- o **Incorrect Placement:** "Address" is incorrectly placed here. The word that should describe the forces is **armed (D)**, which fits better in the context of "armed forces."
- o **Correct Swap: Address (C)** should be swapped with **armed (D)** because it makes more sense to "address evolving security issues."

**Correct Swapping:**

- **A-E:** "Challenges" and "focuses" should be swapped because Tarang Shakti **focuses** on improving capabilities and addressing challenges, not the other way around.
- **C-D:** "Address" and "armed" should be swapped because "armed forces" is the correct term, and "address" fits in describing how forces handle evolving security issues.

**Corrected Sentence:**

"Tarang Shakti-2024 **focuses (A)** on improving strategic **defense (B)** capabilities and fostering collaboration between **armed (D)** forces to **address (C)** evolving security **challenges (E)**."

**Conclusion:**

- **A-E:** "Focuses" should be in place of "challenges."
- **C-D:** "Armed forces" is the correct phrase, and "address" fits in describing the action regarding security issues.

**(d) A-E & C-D**

**S18. Ans.(b)**

**Sol.** The correct answer is (b) Both (i) and (ii).

Explanation:

- Sentence (i) is grammatically correct. It correctly describes how the books are organized by genre in the library, making them easy to locate.
- Sentence (ii) is also correct. It properly conveys that the proposal was submitted via email to the supervisor, who reviewed it carefully.
- Sentence (iii) is incorrect. The phrase "Hardly the meeting had begun" is incorrect. The correct construction should be "Hardly had the meeting begun" to follow the correct inversion rule after words like "hardly," "scarcely," and "barely."

Corrected version of sentence (iii):

"Hardly had the meeting begun when the fire alarm sounded."

Thus, the answer is (b) Both (i) and (ii).

**S19. Ans.(d)**

**Sol.** The statements (ii) and (iii) are grammatically and contextually correct, while (i) contains an error ("though" should be "through").

Analysis of each statement:

1. (i) She is working tirelessly though the night to finish the project by the deadline on Friday.
  - o This sentence has a grammatical error. The phrase "though the night" should be "through the night" as "though" is incorrect in this context.
  - o Correct version: "She is working tirelessly through the night to finish the project by the deadline on Friday."
2. (ii) Seldom have we witnessed such an incredible performance, captivating the audience from beginning to end.
  - o This sentence is correct. It uses proper inversion ("Seldom have we witnessed...") after a negative adverb and is grammatically and contextually sound.
3. (iii) The list of items for the event, including decorations and food, has been finalized by the team.
  - o This sentence is grammatically correct. "The list" is the subject, and the singular verb "has been" correctly agrees with it.

**S20. Ans.(d)**

**Sol.** Both (ii) and (iii) are grammatically incorrect.

**Analysis of each statement:**

1. (i) Each of the participants brought his/her own materials, ensuring that the workshop ran smoothly and without interruptions.
    - o This sentence is grammatically correct. "Each of the participants" is singular, so "his/her" and "brought" are appropriately used.
  2. (ii) Neither of the candidates have revealed his/her full agenda, but both promise significant reforms if elected.
    - o This sentence is incorrect. "Neither" is singular, so the verb should be singular as well. It should be "has" instead of "have."
    - o Correct version: "Neither of the candidates has revealed his/her full agenda..."
  3. (iii) Either the teacher or the students is responsible for ensuring the room is left clean after class.
    - o This sentence is incorrect. When "either... or" is used with a singular and plural subject, the verb should agree with the closest subject (in this case, "students"). The verb should be "are," not "is."
-

**S21. Ans.(a)**

**Sol.** Only **(a)** is grammatically incorrect.

**Analysis of each statement:**

1. **(a) Not only the team completed the task ahead of time, but they also exceeded expectations.**
  - o This sentence is **incorrect** because the phrase "Not only" should be followed by an inverted sentence structure for it to be grammatically correct. It should be "Not only **did the team complete** the task ahead of time..." to maintain proper form.
  - o **Correct version:** "Not only **did the team complete** the task ahead of time, but they also exceeded expectations."
2. **(b) The quality of the products and the level of customer service have greatly improved since the new management.**
  - o This sentence is **correct**. Both "quality" and "level" are singular, but the verb "have" correctly agrees because they are treated as a compound subject.
3. **(c) Anybody who wants to participate must submit his/her application by Friday, as late entries will not be accepted.**
  - o This sentence is **correct**. "Anybody" is singular, and the use of "his/her" is appropriate for gender neutrality.

This option is **incorrect** because option (a) contains an error.

**S22. Ans.(a)**

**Sol.**

**(i) Despite facing numerous challenges**

- **Correct:** This connector works well as it introduces a contrast, indicating that the team succeeded **despite** the challenges.
- **Combined sentence:** Despite facing numerous challenges, including budget constraints, tight deadlines, and unexpected technical difficulties, the project team managed to deliver an innovative solution that exceeded the client's expectations.

**(ii) Given that the project team**

- **Incorrect:** "Given that" implies a reason or condition that explains the outcome. In this case, the challenges would not be the reason for the team's success, so this connector is not suitable.

**(iii) Even if the challenges**

- **Incorrect:** "Even if" introduces a hypothetical situation. This is not appropriate because the challenges mentioned were real, not hypothetical.

**S23. Ans.(d)**

**Sol.** Both options (ii) and (iii) provide suitable connectors that logically and grammatically combine the two sentences. Option (i) does not fit the context properly.

**Analysis:**

**(i) With the advent of continuous update**

- **Incorrect:** This connector does not make sense because "continuous update" is not the focus of the sentence. It doesn't correctly join the two ideas in (A) and (B).

**(ii) Considering the vast array of**

- **Correct:** This connector works well, as it introduces the reason for why companies must update their systems. It logically joins the sentences.
  - **Combined sentence:** **Considering the vast array of** technological advancements available today, companies must continuously update their processes and systems to stay ahead in an ever-evolving
-

**(iii) Given the wide range of**

- **Correct:** This is another suitable connector. It implies that the wide range of technological advancements is the reason for companies needing to update their processes.
- **Combined sentence:** **Given the wide range of** technological advancements available today, companies must continuously update their processes and systems to stay ahead in an ever-evolving digital landscape.

**S24. Ans.(e)**

**Sol.** All three connectors (i), (ii), and (iii) provide grammatically and contextually correct ways to combine the sentences.

Analysis:

**(i) In light of widespread criticism**

- **Correct:** This connector works well, as it introduces the government's persistence despite opposition, making it relevant to both sentences.
- **Combined sentence:** **In light of widespread criticism**, the government pushed forward with its reform plans and remained determined to bring about change.

**(ii) In the face of intense public scrutiny**

- **Correct:** This connector is a direct match to sentence (A) and provides a logical link to both ideas.
- **Combined sentence:** **In the face of intense public scrutiny**, the government pushed forward with its reform plans and remained determined to bring about change.

**(iii) Amid growing criticism**

- **Correct:** This connector also works well, indicating that the government persisted despite increasing criticism, tying both sentences together contextually.
- **Combined sentence:** **Amid growing criticism**, the government pushed forward with its reform plans and remained determined to bring about change.

**S25. Ans.(c)**

**Sol.** The sentence requires a word that fits both blanks in the context of the subordinates trying to influence the manager's decision by standing outside a specific area. Let's examine the options:

1. **Porch:** This word refers to an area outside a building, which would fit in the second blank. However, it doesn't make sense in the context of "to porch the manager" in the first blank. So, it doesn't fit both blanks. (Eliminate option (a) and (b)).
2. **Lobby:** This word can mean both a physical area (a hallway or large open space in a building) and a verb (to seek to influence someone's decision). In this case, "to lobby the manager" and "stand outside the lobby" both make sense. It fits well in both blanks. (Option (c) fits).
3. **Sway:** This word works for the first blank ("to sway the manager" meaning to influence him), but doesn't fit the second blank ("stand outside the sway" doesn't make sense). (Eliminate option (d) and (e)).

Therefore, the correct answer is **(c) Only (II)**.

**S26. Ans.(e)**

**Sol.**

1. **Burst:**

- o **First blank:** "Heard a sudden burst of inspiration" – This works well, as "burst" refers to a sudden occurrence of something, like inspiration.
- o **Second blank:** "Caused by the burst of light from the night star" – This also fits, as "burst of light" is

---

**Burst**

2. **Blare:**

- o **First blank:** "Heard a sudden blare of inspiration" – This doesn't work, as "blare" refers to a loud, harsh sound, and it doesn't fit with inspiration.
- o **Second blank:** "Caused by the blare of light" – This doesn't work either, as "blare" is not used to describe light.

3. **Flash:**

- o **First blank:** "Heard a sudden flash of inspiration" – This works metaphorically, as a "flash of inspiration" refers to a sudden, brilliant idea.
- o **Second blank:** "Caused by the flash of light from the night star" – This fits perfectly, as a "flash of light" is a common expression.
- o So, **Flash** fits both blanks.

**Conclusion:**

Both **Burst** and **Flash** fit the sentence well. Therefore, the correct answer is **(e) Both (I) and (III)**.

**S27. Ans.(a)**

**Sol.** Let's examine how each word fits into the blanks:

- **Elucidate (I):** This word works well in both blanks. It means to make something clear or explain, which fits the context of explaining abstruse (difficult) concepts and the challenge of doing so without oversimplifying:
  - o "The philosopher endeavored to **elucidate** the abstruse concepts."
  - o "It proved arduous to **elucidate** them without simplifying the intricate details."
- **Actuate (II):** This word means to put into action or motivate, which does not fit the context of explaining concepts:
  - o "The philosopher endeavored to **actuate** the abstruse concepts" doesn't make sense in this context, as it implies causing something to happen rather than explaining.
- **Mandate (III):** This word means to command or give authority, which also doesn't fit the context of explaining or clarifying:
  - o "The philosopher endeavored to **mandate** the abstruse concepts" doesn't make sense, as it implies issuing a command rather than explaining.

Thus, the correct answer is **(a) Only (I)**, as "elucidate" is the only word that fits both blanks.

**S28. Ans.(e)**

**Sol.** Let's examine how each word fits into the blanks:

1. **Alleviate:**

- o **First blank:** "Sought to alleviate tensions" – This works, as "alleviate" means to reduce or ease the severity of something, like tensions between nations.
- o **Second blank:** "Hoping to alleviate a peaceful resolution" – This doesn't fit, as "alleviate" is used to describe reducing a burden or stress, not creating or fostering something like a resolution.

2. **Mitigate:**

- o **First blank:** "Sought to mitigate tensions" – This fits well, as "mitigate" means to reduce the harmful effects of something, making it appropriate for easing tensions.
  - o **Second blank:** "Hoping to mitigate a peaceful resolution" – This doesn't quite work, as "mitigate" is
-

### 3. Ameliorate:

- o **First blank:** "Sought to ameliorate tensions" – This fits well, as "ameliorate" means to improve a situation or make it better, which is appropriate in the context of international tensions.
- o **Second blank:** "Hoping to ameliorate a peaceful resolution" – This also works, as "ameliorate" can mean to improve or foster a better outcome, which fits with a peaceful resolution.

### Conclusion:

The word that best fits both blanks is "**Ameliorate.**"

Thus, the correct answer is **(e) Only (III)**.

### S29. Ans.(b)

**Sol.** Let's analyze how each word fits into the blanks:

- **Undermine (I):** Works well in both blanks. It means to weaken or damage something:
  - o "The lawyer sought to **undermine** the witness's testimony" makes sense, as it implies weakening the testimony by pointing out inconsistencies.
  - o "Aiming to **undermine** the credibility of the opposing argument" also fits well, as it suggests weakening the credibility of the opposing argument.
- **Challenge (II):** Also works in both blanks. It means to question or dispute something:
  - o "The lawyer sought to **challenge** the witness's testimony" makes sense, as the lawyer is disputing the inconsistencies.
  - o "Aiming to **challenge** the credibility of the opposing argument" fits well, as the lawyer is questioning the validity of the opposing argument.
- **Sinuate (III):** This word means to curve or move in a winding or indirect path, which does not fit either blank. It has no connection to questioning testimony or credibility:
  - o "The lawyer sought to **sinuate** the witness's testimony" does not make sense in this context.
  - o "Aiming to **sinuate** the credibility of the opposing argument" also does not make sense.

Thus, the correct answer is **(b) Both (I) and (II)**, as both "undermine" and "challenge" fit well in both blanks.

### S30. Ans.(c)

**Sol.** The paragraph focuses on the connection between physical activity and social interaction to promote physical and emotional well-being. Each sentence relates to how engaging in group or community-based physical activities can benefit health. Let's analyze each statement:

- **Sentence (a)** discusses how participating in recreational sports improves physical health through regular exercise, fitting well with the theme of physical activity.
- **Sentence (b)** talks about the social aspect of exercising in groups, which enhances social bonds and reduces isolation, aligning with the theme of combining physical activity and social interaction.
- **Sentence (c)** mentions regular health checkups and medical screenings for preventing chronic diseases. This introduces a new focus on medical care, which, although related to health, does not tie into the specific theme of physical activity or social interaction.
- **Sentence (d)** highlights the motivational benefits of group fitness activities, which is closely related to both social interaction and staying consistent with physical activity.
- **Sentence (e)** points out how physical activities done in a social or community setting can reduce stress and improve emotional well-being, maintaining the theme of physical activity combined with social benefits.

### Incoherent Sentence:

**Sentence (c)** is the incoherent one because it focuses on medical checkups and preventative healthcare, which, while relevant to overall health, does not align with the main theme of physical activity and social interaction. The rest of the sentences discuss the social and emotional advantages of engaging in physical

---

**S31. Ans.(d)**

**Sol.** Pattern of series –

$$8 + (10^2 + 1) = 109$$

$$109 + (11^2 + 1) = 231$$

$$231 + (12^2 + 1) = 376$$

$$376 + (13^2 + 1) = 546$$

$$546 + (14^2 + 1) = 743$$

$$743 + (15^2 + 1) = 969$$

**S32. Ans.(a)**

**Sol.** Pattern of series –

$$100 \times 2 = 200$$

$$200 \times 2.4 = 480$$

$$480 \times 2.8 = 1344$$

$$1344 \times 3.2 = 4300.8$$

$$4300.8 \times 3.6 = 15482.88$$

$$15482.88 \times 4 = 61931.52$$

**S33. Ans.(c)**

**Sol.** Pattern of series –

$$2 + (7^3 - 7) = 338$$

$$338 + (6^3 - 6) = 548$$

$$548 + (5^3 - 5) = 668$$

$$668 + (4^3 - 4) = 728$$

$$728 + (3^3 - 3) = 752$$

$$752 + (2^3 - 2) = 758$$

**S34. Ans.(b)**

**Sol.** Pattern of series –

$$308 \times 2 - 100 = 516$$

$$516 \times 2 - 100 = 932$$

$$932 \times 2 - 100 = 1764$$

$$1764 \times 2 - 100 = 3428$$

$$3428 \times 2 - 100 = 6756$$

$$6756 \times 2 - 100 = 13412$$

**S35. Ans.(a)**

**Sol.** Since  $A$  is 33.33% less than  $B$ , we have:

$$A = B - \frac{1}{3}B = \frac{2}{3}B$$

The product of LCM and HCF of two numbers  $A$  and  $B$  is equal to the product of the numbers:

$$\text{LCM}(A, B) \times \text{HCF}(A, B) = A \times B$$

Given:

$$A \times B = 294$$

Substitute  $A = 2x$  and  $B = 3x$  :

$$2x \times 3x = 294$$

---

$$B = 21 \text{ and } A = 14$$

$$6A - 20 = 6 \times 14 - 20 = 84 - 20 = 64$$

$$3B - 7 = 3 \times 21 - 7 = 63 - 7 = 56$$

Now, find the LCM of 64 and 56. The prime factorizations are:

$$64 = 2^6$$

$$56 = 2^3 \times 7$$

The LCM is the product of the highest powers of all primes:

$$\text{LCM}(64,56) = 2^6 \times 7 = 64 \times 7 = 448$$

So, **Quantity I > Quantity II**

**S36. Ans.(b)**

**Sol.** Let the monthly income of Rohit be Rs 100a

Amount spend on rent = 40a

$$\text{Amount spend on groceries} = (100a - 40a) \times \frac{1}{3} = \text{Rs } 20a$$

$$\text{Amount invested in scheme B} = (100a - 40a - 20a) \times \frac{3}{10} = \text{Rs } 12a$$

$$\text{Amount invested in scheme C} = (100a - 40a - 20a) \times \frac{5}{10} = \text{Rs } 20a$$

$$\text{Given, } 20a - 12a = 4000$$

$$8a = 4000$$

$$a = 500$$

The monthly income of Rohit = 100a = Rs 50000

**Quantity I:** Required difference = 50000 - 20a

$$= 50000 - 10000 = \text{Rs } 40000$$

So, **Quantity I < Quantity II**

**S37. Ans.(a)**

**Sol.** The profit sharing ratio of A, B and C

$$= P \times 4 + 0.6P \times 8 : (P + 5000) \times 12 : 6000 \times 8$$

$$= 2.2P : 3P + 15000 : 12000$$

$$\text{The profit share of C} = \frac{60}{343} \times 17150 = \text{Rs } 3000$$

$$\text{ATQ, } \frac{12000}{2.2P + 3P + 15000} = \frac{3000}{14150}$$

$$14150 \times 4 = 5.2P + 15000$$

$$41600 = 5.2P$$

$$8000 = P$$

The profit sharing ratio of A, B and C = 2.2P : 3P + 15000 : 12000

$$= 17600 : 39000 : 12000$$

$$= 88 : 195 : 60$$

$$\text{Required profit} = 17150 \times \frac{195}{343} = \text{Rs } 9750$$

**S38. Ans.(a)**

**Sol.** Cumulative compound interest =  $\left(20 + 20 + \frac{20 \times 20}{100}\right)\% = 44\%$

$$\text{ATQ, } P \times \frac{44}{100} - \left(P \times \frac{20}{100} \times 2\right) = 260$$

$$\frac{44P}{100} - \frac{40P}{100} = 260$$

**Quantity I:** Required interest =  $\left(6500 \times \frac{3}{4} \times \frac{6}{100} \times 4\right)$

= 1170 Rs

So, **Quantity I > Quantity II**

**S39. Ans.(b)**

**Sol.** Amount invested in scheme A and B together =  $6X/3 = 2X$

Amount invested in post office =  $(6X - 2X) - 2100 = P$

=  $4X - 2100 = P$

Given, X : P=3:5

Let X and P be 3a and 5a respectively

$4(3a) - 2100 = 5a$

$12a - 5a = 2100$

$a = 300$

$X = 3a = 900$

$P = 5a = 1500$

So, Amount invested in scheme A and B together =  $2X = 1800$

Amount invested in scheme A =  $1800 \times \frac{1}{8} = 225 \text{ Rs}$

Amount invested in scheme B =  $1800 \times \frac{7}{8} = 1575 \text{ Rs}$

Amount invested in post office = Rs 1500

**From I.** Amount invested in scheme B is more than the amount invested in post office. (it is correct)

**From II.** Amount spend on maid is more than the amount spend on scheme A (it is correct)

III. Amount invested in scheme B is less than Amount spend on maid (it is incorrect)

So, **Both I & II**

**S40. Ans.(e)**

**Sol.** Let the height and the radius of the cylindrical vessel be h and r cm respectively.

**From I.**  $\frac{75}{100} \times \frac{22}{7} \times r^2 \times h = 1155$

$r^2 \times h = 490 \dots (i)$

And

$2 \times \frac{22}{7} \times r \times h = 440$

$r \times h = 70$

$h = \frac{70}{r}$

h value put in (i)

$r^2 \times \frac{70}{r} = 490$

$r = 7 \text{ cm}$

And  $h = 70/7 = 10 \text{ cm}$

Breadth of the rectangle =  $10 + 10 = 20 \text{ cm}$

Length of the rectangle =  $4 + 7 = 11 \text{ cm}$

Area of the rectangle =  $20 \times 11 = 220 \text{ cm}^2$

**From II.**  $\frac{75}{100} \times \frac{22}{7} \times r^2 \times h = 3696$

$$r^2 \times h = 1568 \dots (i)$$

And

$$2 \times \frac{22}{7} \times r \times h = 704$$

$$r \times h = 112$$

$$h = \frac{112}{r}$$

h value put in (i)

$$r^2 \times \frac{112}{r} = 1568$$

$$r = 14 \text{ cm}$$

$$\text{And } h = 112/14 = 8 \text{ cm}$$

$$\text{Breadth of the rectangle} = 10 + 8 = 18 \text{ cm}$$

$$\text{Length of the rectangle} = 4 + 14 = 18 \text{ cm}$$

$$\text{Area of the rectangle} = 18 \times 18 = 324 \text{ cm}^2$$

So, II is possible to fill all the respective fillers

**From III.**  $\frac{75}{100} \times \frac{22}{7} \times r^2 \times h = 1386$

$$r^2 \times h = 588 \dots (i)$$

And

$$2 \times \frac{22}{7} \times r \times h = 528$$

$$r \times h = 84$$

$$h = \frac{84}{r}$$

h value put in (i)

$$r^2 \times \frac{84}{r} = 588$$

$$r = 7 \text{ cm}$$

$$\text{And } h = 84/7 = 12 \text{ cm}$$

$$\text{Breadth of the rectangle} = 10 + 12 = 22 \text{ cm}$$

$$\text{Length of the rectangle} = 4 + 7 = 11 \text{ cm}$$

$$\text{Area of the rectangle} = 11 \times 22 = 242 \text{ cm}^2$$

So, III is possible to fill all the respective fillers

**S41. Ans.(c)**

**Sol.** Speed of the bus  $2X$  km/hr

Given,  $\frac{672+2X}{3} = 2X$

$$672 + 2X = 6X$$

$$168 = X$$

$$\text{New speed of the car} = 168 \times \frac{3}{4} = 126 \text{ km/hr}$$

Car reached point B in 7 hours

$$\text{Total distance between points A and B} = 7X = 7 \times 168 = 1176 \text{ km}$$

$$\text{Time taken by the car with new speed (taking halt for 10 minutes)} = \frac{1176}{126} + 10 \text{ minutes}$$

$$= 9 \text{ hours } 30 \text{ minutes}$$

**S42. Ans.(b)**

**Sol.** Speed of the boat in still water =  $5 \times 4 = 20$  km/hr

ATQ,

$$\frac{D}{20 - 5} - \frac{D}{20 + 5} = 10$$

$$\frac{D}{15} - \frac{D}{25} = 10$$

$$5D - 3D = 75 \times 10$$

$$2D = 750$$

$$D = 375$$

**Quantity I:** Required time =  $\frac{D-75}{20+5} = \frac{375-75}{25} = 12$  hours

**Quantity II:** Required time =  $\frac{D+45}{20-5} = \frac{375+45}{15} = 28$  hours

So, **Quantity I < Quantity II**

**Solutions (43-48):** Let total number of type B pencil manufactured by all three companies =  $500x$

So, total number of type A pencil manufactured in all three companies =  $500x \times \frac{60}{100} = 300x$

Total type B pencil manufactured by Z =  $500x \times \frac{3}{10} = 150x$

Total number of pencils manufactured by X =  $(500x+300x) \times \frac{1}{2} = 400x$

Let number of type A pencil manufactured in Z = number of type A pencil manufactured by Y =  $y$

And, let total number of type B pencil manufactured by Y =  $z$

So, total number of type A pencil manufactured in X =  $y+z$

And total number of type B pencil manufactured in X =  $400x - (y+z)$

Companies	Total type A pencil manufactured	Total type B pencil manufactured
X	$y+z$	$400x - y - z$
Y	$y$	$z$
Z	$y$	$150x$
Total	$300x$	$500x$

So,  $3y + z = 300x$  -----(i)

Also,  $550x - y = 500x$

$$y = 50x$$

Now,  $z = 300x - 3 \times 50x$

$$z = 150x$$

Companies	Total type A pencil manufactured	Total type B pencil manufactured
X	$200x$	$200x$
Y	$50x$	$150x$
Z	$50x$	$150x$

**S43. Ans.(e)**

**Sol.**  $200x - 150x = 300$

$$50x = 300$$

$$x = 6$$

**S44. Ans.(d)**

**Sol.** ATQ,  $\frac{350x}{2} = 1050$

$350x = 2100$

$x = 6$

Total number of pencils manufactured by N =  $400 \times 6 \times \frac{125}{100} = 3000$

Number of type B pencils manufactured by Z & number of type A pencils manufactured by Y together =  $150 \times 6 + 50 \times 6 = 1200$

Required difference =  $3000 - 1200 = 1800$

**S45. Ans.(c)**

**Sol.** Total pencils manufactured by M =  $4 \times (200x + 50x) = 1000x$

Total type B pencils manufactured by all three companies =  $500x$

ATQ,  $1000x - 500x = 2000$

$x = 4$

Required value =  $(500+300) \times 4 = 3200$

**S46. Ans.(a)**

**Sol.** Required ratio =  $150x : 200x = 3:4$

**S47. Ans.(b)**

**Sol.** Required answer (A) =  $\frac{500x}{200x} \times 100 = 250\%$

**S48. Ans.(a)**

**Sol.**  $D = 150x - 50x = 100x$

Required percentage =  $\frac{100x}{150x} \times 100 = 66.66\%$

**S49. Ans.(c)**

**Sol.** Equation (I):

I.  $2x^2 - 11x + p = 0$

Put  $x = 2$

$2 \times 4 - 22 + p = 0$

$8 - 22 + p = 0$

$p = 14$

Now,

$2x^2 - 11x + 14 = 0$

$2x^2 - 7x - 4x + 14 = 0$

$x(2x-7) - 2(2x-7) = 0$

$(2x - 7)(x - 2) = 0$

$x = \frac{7}{2}, 2$

II.  $2y^2 - 15y + q = 0$

Put  $y = 2 \times 3 = 6$

$2 \times 36 - 90 + q = 0$

$72 - 90 + q = 0$

$$2y^2 - 15y + 18 = 0$$

$$2y^2 - 12y - 3y + 18 = 0$$

$$2y(y - 6) - 3(y - 6) = 0$$

$$y = 6, 3/2$$

$$\text{Required product} = 14 \times 18 = 252$$

**S50. Ans.(e)**

**Sol.** Let  $100x = Y$

ATQ,

$$100x \times \frac{160}{100} \times \frac{75}{100} = 100x + 40$$

$$20x = 40$$

$$x = 2$$

**Quantity I:** Marked price of product =  $160x = \text{Rs.}320$

**Quantity II:** Cost price of the article =  $100x \times \frac{160}{100} \times \frac{75}{100} = 120x \text{ Rs}$

Given,  $x = 2$

So, selling price of the article =  $120 \times 2 \times \frac{4}{3} = 320 \text{ Rs}$

So, **Quantity I = Quantity II**

**Solutions (51-55): For shop A,** Total glasses sold =  $\frac{50}{100} \times 968 = 484$

Total plats sold =  $968 - 484 = 484$

**For shop C,** Total utensils (Glass and Plats) sold =  $\frac{100}{56} \times 504 = 900$

Total glasses sold =  $900 - 504 = 396$

**S51. Ans.(a)**

**Sol.** Multiple of 8 = 8, 16, 24, 32

Odd place multiple is 8 and 24.

Percentage range =  $8 < X < 30$

$$X = 24\%$$

Number of plats sold by shop D =  $(100 - 24)/100 \times 900 = 684$

**S52. Ans.(e)**

**Sol.** Number of plats sold by B =  $146 + 3 \times (968 - 900) = 350$

$$\text{Required answer} = 900 + 350 \times \frac{65}{35}$$

$$= 900 + 650 = 1550$$

**S53. Ans.(d)**

**Sol.** Total number utensils (Glass and Plats) sold in Y =  $3 \times 484 = 1452$

Number of plats sold by Y =  $3/4 \times 1452 = 1089$

Required sum  $(1452 - 1089) + 396 = 759$

**S54. Ans.(d)**

**Sol.** Total number glasses sold by B =  $\frac{968+900}{2} - 414$

$$= 934 - 414 = 520$$

**S55. Ans.(e)**

**Sol.** Total number of students in Q =  $822 \times 4 - (900+900+968)$   
 $= 3288 - 2768 = 520$

Number plats sold by shop B =  $\frac{35}{100} \times 520 = 182$

**S56. Ans.(d)**

**Sol.** Let total number of people in A and B be a & b respectively.

ATQ -

$$a \times \frac{(100-60)}{100} \times \frac{75}{100} = 1800$$

$$\frac{3a}{10} = 1800$$

$$a = 6000$$

Also,  $b \times \frac{40}{100} \times \frac{3}{10} = 600$

$$b = 5000$$

$$\text{Required percentage} = \frac{6000-5000}{5000} \times 100 = 20\%$$

**S57. Ans.(d)**

**Sol.** Let total number of people in B = x

ATQ -

$$x \times \frac{(100-40)}{100} \times \frac{60}{100} = 2880$$

$$\frac{9x}{25} = 2880$$

$$x = 8000$$

$$\text{Total males not attending the seminar from B} = 8000 \times \frac{40}{100} \times \frac{2}{5} = 1280$$

Let total number of people in C = y

So,

$$y \times \frac{45}{100} \times \frac{58}{100} - y \times \frac{55}{100} \times \frac{30}{100} = 384$$

$$y = 4000$$

$$\text{Total males not attending the seminar from C} = 4000 \times \frac{45}{100} \times \frac{42}{100} = 756$$

$$\text{Required difference} = 1280 - 756 = 524$$

**S58. Ans.(c)**

**Sol.** Let total number of people in D = z

ATQ -

$$z \times \frac{(100-55)}{100} \times \frac{50}{100} = 2250$$

$$\frac{9z}{40} = 2250$$

$$z = 10000$$

**S59. Ans.(b)**

**Sol.** Let total number of people in A = n

$$n \times \frac{(100-60)}{100} \times \left(\frac{75-25}{100}\right) = 1200$$

$$\frac{n}{5} = 1200$$

$$n = 6000$$

Let total number of people in D= m

$$m \times \frac{(100-55)}{100} \times \frac{50}{100} = 2700$$

$$\frac{9m}{40} = 2700$$

$$m = 12000$$

$$\text{Total people not attending the seminar from D} = 12000 \times \frac{55}{100} = 6600$$

$$\text{Required ratio} = 6600 : 6000 = 11 : 10$$

**S60. Ans.(c)**

**Sol.** Total number of people in A be 2y

So, total number of people in C =  $2y \times \frac{3}{2} = 3y$

$$3y \times \frac{(100-45)}{100} \times \frac{(100-30)}{100} - 2y \times \frac{(100-60)}{100} \times \frac{(100-25)}{100} = 4440$$

$$\frac{231y}{200} - \frac{3y}{5} = 4440$$

$$\frac{231y-120y}{200} = 4440$$

$$\frac{111y}{200} = 4440$$

$$y = 8000$$

$$\text{Total males attending the seminar from both the cities} = 16000 \times \frac{40}{100} \times \frac{25}{100} + 24000 \times \frac{55}{100} \times \frac{30}{100}$$

$$= 1600 + 3960 = 5560$$

$$\text{Required average} = \frac{5560}{2} = 2780$$

**Solutions (61-65):** Final Arrangement is here:

Floors	Persons	Fruits	Countries
6	F	Watermelon	Chile
5	E	Guava	Japan
4	C	Mango	Canada
3	B	Grapes	Norway
2	D	Apple	Italy
1	A	Pineapple	Brazil

**S61. Ans.(c)**

**S62. Ans.(b)**

**S63. Ans.(c)**

**S64. Ans.(b)**

**S65. Ans.(d)**

**Solutions (66-70): Logic here is:**

**Words:** The words with maximum number of letters are taken and placed in extreme left end in each step.

**Numbers:** The smallest number is taken and if that number is an even number 11 is added to that number and if it is an odd number 11 is subtracted from that number then after the applying all the operations the number is placed in extreme right end.

In step 6 the numbers are arranged in ascending order after the words.

**Input: speed 56 bike 23 increasing 34 of 49 rapidly 76**

Step 1: increasing speed 56 bike 34 of 49 rapidly 76 12

Step 2: rapidly increasing speed 56 bike of 49 76 12 45

Step 3: speed rapidly increasing 56 bike of 76 12 45 38

Step 4: bike speed rapidly increasing of 76 12 45 38 67

Step 5: of bike speed rapidly increasing 12 45 38 67 87

Step 6: of bike speed rapidly increasing 12 38 45 67 87

S66. Ans.(a)

S67. Ans.(e)

S68. Ans.(c)

S69. Ans.(d)

S70. Ans.(c)

**Solutions (71-75): Final Arrangement is here:**

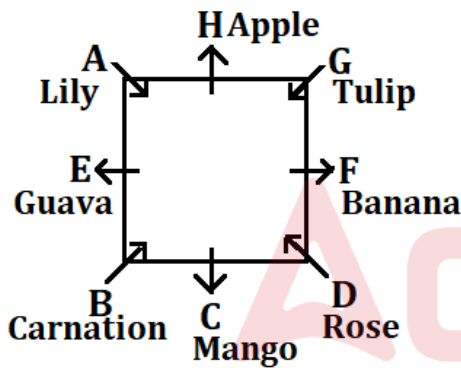

S71. Ans.(b)

S72. Ans.(e)

S73. Ans.(c)

S74. Ans.(b)

Sol. Except G, all the others sit on the middle of the sides of table.

S75. Ans.(d)

S76. Ans.(b)

Sol. MALNOURISHED = LBKMPVQJRGFC

VRQPMLKJGFCB

**Solutions (77-81):** Final Arrangement is here:

Years	Ages	Persons	Things
1972	52	T	Chains
1975	49	U	Locks
1976	48	R	Stapler
1982	42	Q	Keys
1987	37	S	Locket
1993	31	V	Pins
2005	19	P	Glass

**S77. Ans.(d)**

**S78. Ans.(d)**

**S79. Ans.(b)**

**S80. Ans.(e)**

**S81. Ans.(c)**

**Sol.** Except T, ages of all the other persons are an odd number.

**Solutions (82-84):**

Final Arrangement is here:

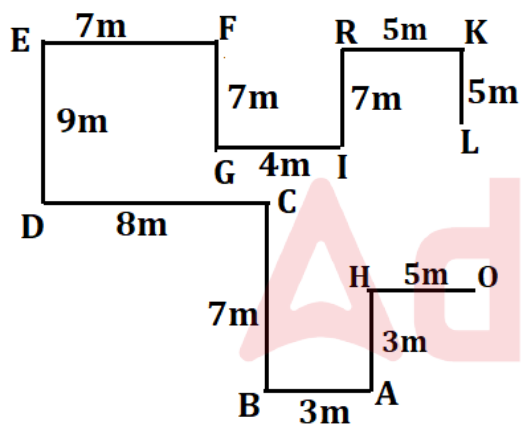

**S82. Ans.(c)**

**S83. Ans.(d)**

**S84. Ans.(e)**

**Sol.** Except F-R, in all the other options first point is south-east of the second point.

**Solutions (85-88):**

**S85. Ans.(d)**

**Sol.** Statement (I) – True. In remote areas, people lack access to banking services, which could cause them

**S86. Ans.(a)**

**Sol.** Statement (I) – True. The scheme directly transferred subsidies into bank accounts, which likely reduced the role of intermediaries.

Statement (II) – True. Since the scheme required bank accounts, many people in rural areas without access to banks might have been left out.

Statement (III) – False. The statement doesn't provide specific information about urban areas benefiting more from the scheme.

**S87. Ans.(e)**

**Sol.** Statement (I) – True. If people still rely on agents, it contradicts the goal of reducing intermediaries.

Statement (II) – True. Lack of access to mobile phones could hinder the use of digital banking.

Statement (III) – True. Delays due to technical issues would also challenge the scheme's effectiveness.

**S88. Ans.(e)**

**Sol.** Statement (I) – True. If beneficiaries received their subsidies on time, it supports the efficiency of the scheme.

Statement (II) – True. An increase in bank account openings indicates more people are gaining access to the scheme.

Statement (III) – True. Transparency in subsidy distribution aligns with the scheme's motive.

**S89. Ans.(c)**

**Sol.**

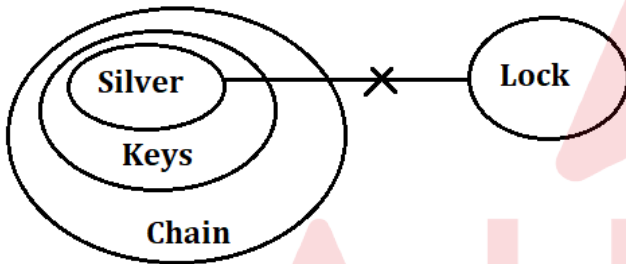

**S90. Ans.(d)**

**Sol.**

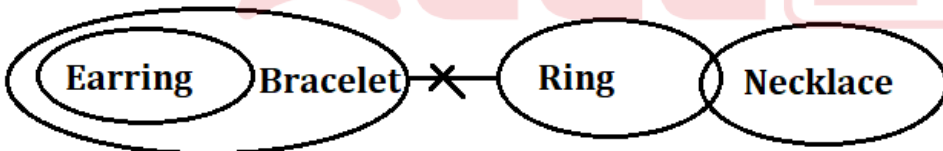

**S91. Ans.(e)**

**Sol.**

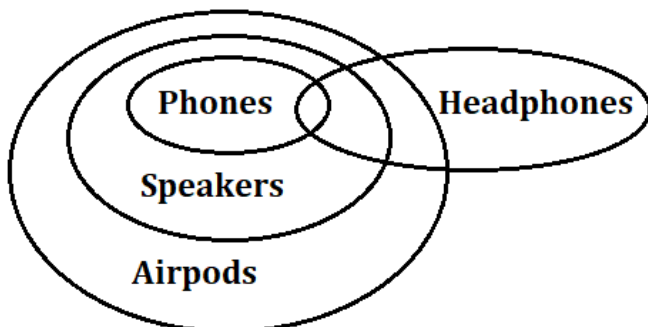

**S92. Ans.(d)**

**Sol.** Statement (III) - True: Evidence of marine animals dying due to plastic directly supports the need for regulations.

**S93. Ans.(b)**

**Sol.** Statement (III) - True: This weakens the argument of businesses to continue using plastic.

**S94. Ans.(a)**

Statement (I) - True: Governments are taking action as mentioned in the environmentalists' demands for stricter regulations.

Statement (II) - True: The debate revolves around the environmental and economic implications of plastic use.

Statement (III) - False: While many businesses are concerned about costs, it is not stated that most are entirely against regulations.

**S95. Ans.(b)**

Statement (I) - True: Businesses may transfer the cost burden to consumers.

Statement (II) - True: A reduction in plastic use could have a positive environmental impact.

Statement (III) - False: The passage doesn't suggest that alternatives will necessarily lead to reduced costs in the long term.

**S96. Ans.(c)**

**Sol. From Statement I and III:**

Days	Persons
Monday	U
Tuesday	V
Wednesday	S
Thursday	W
Friday	R
Saturday	T

R booked movie ticket on Friday.

**S97. Ans.(b)**

**Sol. From Statement I:**

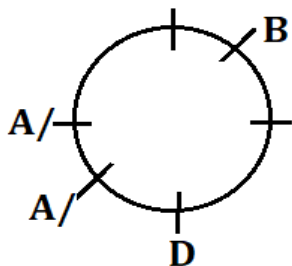

From Statement II and III:

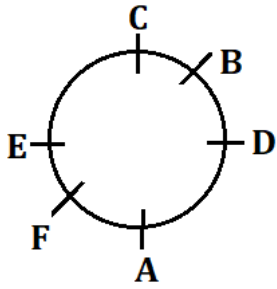

C sits immediately to the left of E.

S98. Ans.(d)

Sol. From Statement I, II and III:

Words	Code
process	my
is	op
fast	ur
systematically	vu
initiated	tv
legal	ts
matters/official	mk/ik
slowly	mi
the/system	pi/kl

The code for process initiated is "my tv".

S99. Ans.(b)

Sol. From Statement I and II:

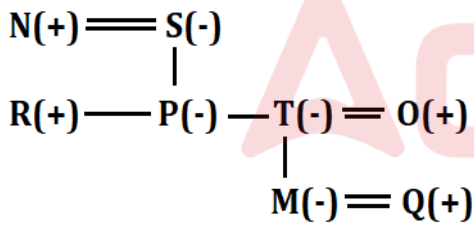

S is the grandmother of M.

Solutions (100-103):

Final Arrangement is here:

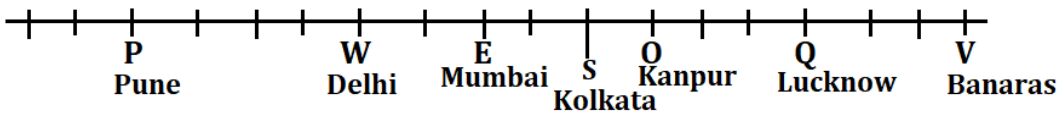

S100. Ans.(c)

S101. Ans.(c)

S102. Ans.(d)

S103. Ans.(e)

**S104. Ans.(d)**

**Sol.** Using the second, fourth, sixth, and ninth letters of the word "ABANDONED" the meaningful word formed is: BOND

**Solutions (105-108):**

Final Arrangement is here:

F > G > B (126Kg) > E > A > C > D

**S105. Ans.(a)****S106. Ans.(c)****S107. Ans.(e)****S108. Ans.(a)****S109. Ans.(b)**

**Sol.** Statement (I) - True - Urbanization without proper planning leads to resource overconsumption, which is clearly mentioned in the passage.

Statement (II) - True - The passage mentions that the lack of sustainable practices is contributing to environmental problems.

Statement (III) - False - The passage focuses on urban areas, but it does not state that rural population increases have no impact.

**S110. Ans.(a)**

**Sol.** Statement (I) - True - The passage mentions that sustainable urban development practices are crucial for reducing environmental degradation.

Statement (II) - False - Reducing population growth in urban areas is not suggested in the passage.

Statement (III) - False - Enhancing deforestation for urban expansion would further contribute to environmental degradation.

**S111. Ans.(c)**

**Sol.** Statement (I) - True - The passage suggests that urbanization without planning leads to environmental issues such as pollution.

Statement (II) - True - Overconsumption of resources is a key consequence mentioned in the passage.

Statement (III) - False - The passage does not discuss better access to healthcare or education as a consequence of unplanned urbanization.

**S112. Ans.(c)**

**Sol.** Statement (I) - False - The passage suggests that the problem still exists due to the lack of sustainable practices.

Statement (II) - True - The passage focuses on urban expansion as a cause of environmental degradation, not rural deforestation.

---

**Solutions (113-115):**

Final Arrangement is here:

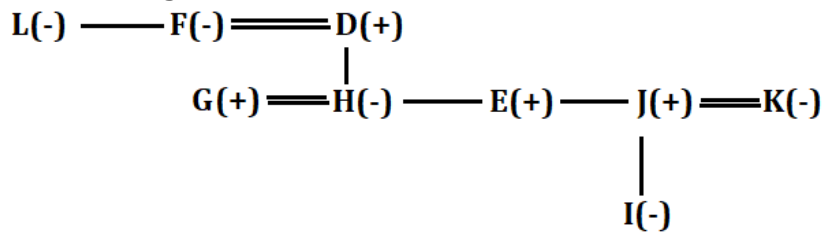

**S113. Ans.(d)**

**S114. Ans.(e)**

**S115. Ans.(d)**

**S116. Ans.(d)**

**Sol. 64376759247 = 86158537465**

$8+1+8+3+4+5 = 29$

**S117. Ans.(d)**

Statement (I) - True: Higher cost of production can indeed be a factor.

Statement (II) - True: The passage mentions financial constraints and lack of infrastructure as major obstacles.

Statement (III) - False: The passage clearly states that governments are focused on renewable energy, so this is incorrect.

**S118. Ans.(b)**

Statement (I) - True: The passage emphasizes financial and infrastructure challenges.

Statement (II) - True: Investing in research and development is a logical course of action to improve renewable energy production.

Statement (III) - False: Hybrid energy solutions are not mentioned in the passage, so we cannot assume this.

**S119. Ans.(c)**

Statement (I) - True: The passage mentions the rise in renewable energy production but states that it is still insufficient.

Statement (II) - False: Financial constraints are a major reason but not the only one; infrastructure is also a factor.

Statement (III) - True: It is reasonable to infer that the cheaper production costs of fossil fuels contribute to their dominance.

**S120. Ans.(a)**

Statement (I) - True: If renewable energy has surpassed fossil fuels in some regions, it weakens the argument that fossil fuels dominate globally.

Statement (II) - True: The decreasing cost of renewable energy undermines the idea that financial constraints are the primary obstacle.

Statement (III) - False: The passage focuses on financial and infrastructure challenges, not political will, so this does not weaken the argument.